



User Guide

R2110

High Speed Smart LTE Router

4 Eth + 1 RS-232 + 1 RS-485 + 1 Bluetooth



robustOS

Guangzhou Robustel LTD

www.robustel.com

About This Document

This document provides hardware and software information of the Robustel R2110 Router, including introduction, installation, configuration and operation.

Copyright©2019 Guangzhou Robustel LTD

All rights reserved.

Trademarks and Permissions

robustel robustOS are trademark of Guangzhou Robustel LTD. All other trademarks and trade names mentioned in this document are the property of their respective owners.

Disclaimer

No part of this document may be reproduced in any form without the written permission of the copyright owner. The contents of this document are subject to change without notice due to continued progress in methodology, design and manufacturing. Robustel shall have no liability for any error or damage of any kind resulting from the use of this document.

Technical Support

Tel: +86-20-29019902

Fax: +86-20-82321505

Email: support@robustel.com

Web: www.robustel.com

Important Notice

Due to the nature of wireless communications, transmission and reception of data can never be guaranteed. Data may be delayed, corrupted (i.e., have errors) or be totally lost. Although significant delays or losses of data are rare when wireless devices such as the router is used in a normal manner with a well-constructed network, the router should not be used in situations where failure to transmit or receive data could result in damage of any kind to the user or any other party, including but not limited to personal injury, death, or loss of property. Robustel accepts no responsibility for damages of any kind resulting from delays or errors in data transmitted or received using the router, or for failure of the router to transmit or receive such data.

Safety Precautions

General

- The router generates radio frequency (RF) power. When using the router, care must be taken on safety issues related to RF interference as well as regulations of RF equipment.
- Do not use your router in aircraft, hospitals, petrol stations or in places where using cellular products is prohibited.
- Be sure that the router will not be interfering with nearby equipment. For example: pacemakers or medical equipment. The antenna of the router should be away from computers, office equipment, home appliance, etc.
- An external antenna must be connected to the router for proper operation. Only uses approved antenna with the router. Please contact authorized distributor on finding an approved antenna.
- Always keep the antenna with minimum safety distance of 20 cm or more from human body. Do not put the antenna inside metallic box, containers, etc.
- RF exposure statements
 1. For mobile devices without co-location (the transmitting antenna is installed or located more than 20cm away from the body of user and nearby person)
- FCC RF Radiation Exposure Statement
 1. This Transmitter must not be co-located or operating in conjunction with any other antenna or transmitter.
 2. This equipment complies with FCC RF radiation exposure limits set forth for an uncontrolled environment. This equipment should be installed and operated with a minimum distance of 20 centimeters between the radiator and human body.

Note: Some airlines may permit the use of cellular phones while the aircraft is on the ground and the door is open. Router may be used at this time.

Using the Router in Vehicle

- Check for any regulation or law authorizing the use of cellular devices in vehicle in your country before installing the router.
- The driver or operator of any vehicle should not operate the router while driving.
- Install the router by qualified personnel. Consult your vehicle distributor for any possible interference of electronic parts by the router.
- The router should be connected to the vehicle's supply system by using a fuse-protected terminal in the vehicle's fuse box.
- Be careful when the router is powered by the vehicle's main battery. The battery may be drained after extended period.

Protecting Your Router

To ensure error-free usage, please install and operate your router with care. Do remember the following:

- Do not expose the router to extreme conditions such as high humidity / rain, high temperature, direct sunlight,

caustic / harsh chemicals, dust, or water.

- Do not try to disassemble or modify the router. There is no user serviceable part inside and the warranty would be void.
- Do not drop, hit or shake the router. Do not use the router under extreme vibrating conditions.
- Do not pull the antenna or power supply cable. Attach/detach by holding the connector.
- Connect the router only according to the instruction manual. Failure to do it will void the warranty.
- In case of problem, please contact authorized distributor.

Regulatory and Type Approval Information

Table 1: Directives



2011/65/EU	The European RoHS 2011/65/EU Directive was issued by the European parliament and the European Council on 1 July 2011 on the restriction of the use of certain Hazardous substances in electrical and electronic equipment.	
2012/19/EU	The European WEEE 2012/19/EU Directive was issued by the European parliament and the European Council on 24 July 2012 on waste electrical and electronic equipment.	
2013/56/EU	The European 2013/56/EU Directive is a battery Directive which published in the EU official gazette on 10 December 2013. The button battery used in this product conforms to the standard of 2013/56/EU directive.	

Table 2: Standards of the electronic industry of the People's Republic of China

SJ/T 11363-2006	<p>The electronic industry standard of the People's Republic of China SJ/T 11363-2006 "Requirements for Concentration Limits for Certain Toxic and Hazardous Substances in Electronic Information Products" issued by the ministry of information industry of the People's Republic of China on November 6, 2006, stipulates the maximum allowable concentration of toxic and hazardous substances in electronic information products.</p> <p>Please see Table 3 for an overview of toxic or hazardous substances or elements that might be contained in product parts in concentrations above the limits defined by SJ/T 11363-2006.</p>
SJ/T 11364-2014	<p>The electronic industry standard of the People's Republic of China SJ/T 11364-2014 "Labeling Requirements for Restricted Use of Hazardous Substances in Electronic and Electrical Products" issued by the ministry of Industry and information technology of the People's Republic of China on July 9, 2014, stipulates the Labeling requirements of hazardous substances in electronic and electrical products, environmental protection use time limit and whether it can be recycled. This standard is applicable to electronic and electrical products sold within the territory of the People's Republic of China, and can also be used for reference in the logistics process of electronic and electrical products.</p> <p>The orange logo below is used for Robustel products:</p> <div style="text-align: right;">  </div> <p>Indicates its warning attribute, that is, some hazardous substances are contained in the product. The "10" in the middle of the legend refers to the environment-friendly Use Period (EFUP) * of electronic information product, which is 10 years. It can be used safely during the environment-friendly Use Period. After the environmental protection period of use, it should enter the recycling system.</p> <p>*The term of environmental protection use of electronic information products refers to the term during which the toxic and hazardous substances or elements contained in electronic information products will not be leaked or mutated and cause serious pollution to the environment or serious damage to people and property under normal conditions of use.</p>

Table 3: Toxic or Hazardous Substances or Elements with Defined Concentration Limits

Name of the Part	Hazardous Substances					
	(Pb)	(Hg)	(Cd)	(Cr (VI))	(PBB)	(PBDE)
Metal parts	o	o	o	o	o	o
Circuit modules	o	o	o	o	o	o
Cables and cable assemblies	o	o	o	o	o	o
Plastic and polymeric parts	o	o	o	o	o	o

o:
Indicates that this toxic or hazardous substance contained in all of the homogeneous materials for this part is below the limit requirement in 2011/65/EU and SJ/T11363-2006.

x:
Indicates that this toxic or hazardous substance contained in at least one of the homogeneous materials for this part *might exceed* the limit requirement in 2011/65/EU and SJ/T11363-2006.

Document History

Updates between document versions are cumulative. Therefore, the latest document version contains all updates made to previous versions.

Date	Firmware Version	Document Version	Change Description
Apr. 17, 2019	1.0.0	v.1.0.0	Initial release
Apr. 30, 2019	1.0.0	v.1.0.1	<ul style="list-style-type: none">Revised the Dimensions of productAdded the information of ApprovalsRevised the Regulatory and Type Approval InformationRevised the description of Robustlink and change it to RCMSRevised the Data speed
May. 22, 2019	1.0.0	v.1.0.2	Revised the Dimensions of product and its related picture

Contents

Contents	8
Chapter 1 Product Overview	10
1.1 Key Features	10
1.2 Package Contents	11
1.3 Specifications	13
1.4 Dimensions.....	15
1.5 Ordering Information	16
Chapter 2 Hardware Installation	17
2.1 Definition of 2*5 3.5mm Interface	17
2.2 Definition of Power Interface	18
2.3 LED Indicators.....	18
2.4 USB Interface.....	19
2.5 Reset Button.....	20
2.6 Ethernet Ports	20
2.7 Insert or Remove SIM Card	21
2.8 Attach External Antenna (SMA Type).....	22
2.9 Mount the Router	23
2.10 Ground the Router	25
2.11 Connect the Router to a Computer.....	25
2.12 Power Supply.....	26
Chapter 3 Initial Configuration	26
3.1 Configure the PC.....	28
3.2 Factory Default Settings	31
3.3 Log in the Router	31
3.4 Control Panel	32
3.5 Status.....	33
3.6 Interface > Link Manager	35
3.7 Interface > LAN	45
3.8 Interface > Ethernet	49
3.9 Interface > Cellular	51
3.10 Interface > WiFi	55
3.11 Interface > USB.....	70
3.12 Interface > DI/DO	71
3.13 Interface > Serial Port.....	75
3.14 Network > Route	79
3.15 Network > Firewall	81
3.16 Network > IP Passthrough	86
3.17 VPN > IPsec.....	87
3.18 VPN > OpenVPN	94
3.19 VPN > GRE	103
3.20 Services > Syslog.....	105
3.21 Services > Event.....	106

3.22	Services > NTP	109
3.23	Services > SMS.....	110
3.24	Services > Email.....	111
3.25	Services > DDNS	112
3.26	Services > SSH.....	113
3.27	GPS	114
3.28	Ignition	118
3.29	Services > Web Server	119
3.30	Services > Advanced.....	120
3.31	System > Debug.....	121
3.32	System > Update	122
3.33	System > App Center	123
3.34	System > Tools	124
3.35	System > Profile.....	126
3.36	System > User Management	128
Chapter 4	Configuration Examples.....	130
4.1	Cellular	130
4.1.1	Cellular Dial-Up.....	130
4.1.2	SMS Remote Control.....	132
4.2	VPN Configuration Example	134
4.2.1	IPsec VPN	134
4.2.2	OpenVPN	138
4.2.3	GRE VPN.....	140
Chapter 5	Introductions for CLI.....	142
5.1	What Is CLI.....	142
5.2	How to Configure the CLI	144
5.3	Commands Reference	144
5.4	Quick Start with Configuration Examples.....	145
Glossary.....		151

Chapter 1 Product Overview

1.1 Key Features

The Robustel Industrial Cellular Bluetooth Router (R2110) is a rugged cellular router offering state-of-the-art mobile connectivity for internet of things applications.

R2110 is a powerful platform developed based on RobustOS, a Robustel self-developed and Linux-based operating system which is designed to be used in Robustel devices. The RobustOS includes basic networking features and protocols providing customers with excellent user experience. Meanwhile, RobustOS offers Software Development Kit (SDK) allows partners and customers to develop IoT applications by using C. It also provides various Apps to meet fragmented IoT market demands.

- Supports Gigabit Ethernet port, 802.11ac WiFi
- Dual SIM card redundancy backup, embedded 4G wireless communication module
- The feature Link Manager supports WWAN1, WWAN2, Ethernet WAN, WLAN WAN link backup and ICMP detection.
- The option *Backup Mode* supports cold, warm and load balancing
- Supports BLE 5.0 S (Optional)
- Wifi supports AP mode and client mode
- ETH0 port supports PD access (optional)
- Supports Ignition sensing(optional, Ignition sensing and PD access function can only be selected one by one)
- RobustOS + SDK + App
- Supports multiple VPNs such as IPsec/OpenVPN/GRE/L2TP/PPTP/DMVPN
- Supports network functions such as DDNS/VRRP/DHCP Server
- Supports IP Passthrough
- Supports SMS, Email, DO, SNMP Trap and RCMS event alarms
- Supports Web, CLI, SMS, USB and RCMS upgrade firmware
- Supports RobustVPN cloud platform to provide simple and secure remote access for industrial equipment such as PLC
- Supports SMS and Timed restart
- Robust industrial design (The input voltage range with Ignition sensing is 10 to 30 V DC , The input voltage range

- RP-SMA WiFi antenna (stubby/magnet optional)

Stubby antenna



Magnet antenna



- Bluetooth stubby antenna



- Wall mounting kit



- 35 mm DIN rail mounting kit



- Ethernet cable



- AC/DC power adapter (12V DC, 1.5 A; EU/US/UK/AU plug optional)



1.3 Specifications

Cellular Interface

- Number of antennas: 2 (MAIN + AUX)
- Connector: SMA-K
- SIM: 2 (3.0 V & 1.8 V) Standard SIM; UICC SIM (Optional)
- Standards: FDD LTE/TDD LTE
FDD LTE: max DL/UL = 100/50 Mbps, fallback to 2G/3G
TDD LTE: max DL/UL = 100/50 Mbps, fallback to 2G/3G

Ethernet Interface

- Number of ports: 4 x 10/100/1000 Mbps (3 x LAN + 1 x WAN)
- LAN port: Supports 802.3at PD feature (optional) on ETH3
- Magnet isolation protection: 1 KV

WiFi Interface

- Number of antennas: 2 (WiFi1 + WiFi2)
- Connector: RP-SMA-K
- Standards: 802.11a/b/g/n/ac, 2*2 MIMO, supports AP and Client modes
- Frequency bands: 2.412 - 2.472 GHz (2.4 GHz ISM band)
5.15 - 5.825 GHz (5 GHz ISM band)
- Security: Open, WPA, WPA2, WEP
- Encryption: AES, TKIP, WEP64
- Data speed: 5G: Up to 867Mbps
2.4G: Up to 300Mbps

Bluetooth Interface (Optional)

- Number of antennas: 1
- Connector: RP-SMA-K
- Standards: BLE 5.0 Compatible with BLE 4.2, BLE 4.0

GPS (Optional)

- Number of antennas: 1

- Connector: SMA-K with 50 ohms impedance
- GNSS Technology: GPS, QZSS, GLONASS, Galileo, BeiDou
- Tracking sensitivity: -160 dBm
- Horizontal position accuracy: 2.5 m

Serial Interface

- Number of ports: 1 x RS-232 + 1 x RS-485
- Connector: 2 x 5-pin 3.5 mm female socket
- ESD protection: ± 15 KV
- Baud rate: 300 bps to 115200 bps
- Parameters: 8E1, 8O1, 8N1, 8N2, 7E2, 7O2, 7N2, 7E1
- RS-232: TxD, RxD, RTS, CTS, GND
- RS-485: Data+ (A), Data- (B)

DI / DO

- Type: 1 x DI + 1 x DO, wet contact
- Connector: 2 x 5-pin 3.5 mm female socket
- Isolation: 3KVDC or 2KVrms
- Absolute maximum VDC: "V+" + 30 V DC (DI), 30 V DC (DO)
- Absolute maximum ADC: 100 mA

Others

- 1 x RST button (Tact Switch)
- 1 x Micro SD interface
- 1 x USB 2.0 host, 5 V/500 mA
- LED indicators - 1 x RUN, 1 x Modem, 1 x USR, 1 x RSSI, 1 x NET, 1 x WiFi
Network port indicator (link indicator)
- Built-in: Watchdog, Timer

Software (Basic features of RobustOS)

- Network protocols: PPP, PPPoE, TCP, UDP, DHCP, ICMP, NAT, HTTP, HTTPS, DNS, ARP, NTP, SMTP, Telnet, SSH2, DDNS, etc.
- VPN tunnel: IPsec, OpenVPN, GRE
- Firewall: DMZ, anti-DoS, Filtering (IP/Domain name/MAC address), Port Mapping, Access Control
- Management: Web, CLI, SMS
- Serial port: Transparent, TCP Client/Server, UDP, Modbus RTU to TCP

App Center (Available Apps for RobustOS)

- Apps*: L2TP, PPTP, DMVPN, RobustVPN, VRRP, QoS, SNMP, Language, RobustLink, Bluetooth, Dynamic route
- *Request on demand. For more Apps please visit www.robustel.com.

Power Supply and Consumption

- Connector: 3-pin 3.5 mm female socket with lock
- Input voltage: 10 to 30V DC(With ignition sensing)

9 to 36V DC (Without ignition sensing)

- Power consumption: Idle: 500 mA@12 V
Data link: 1.3 A (peak) @12 V

Physical Characteristics

- Ingress protection: IP30
- Housing & Weight: Aluminum, 500 g
- Dimensions: 125 x 100 x 48 mm (device only)
- Installations: Desktop, wall mounting or 35 mm DIN rail mounting

Approvals

- Environmental: RoHS, WEEE
- Regulatory: CE*, FCC*, RCM*, Telec*, E-Mark*
(*: In progress)

1.4 Dimensions

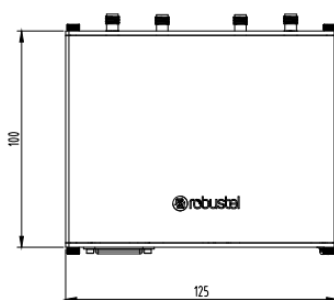

Front View



Rear View

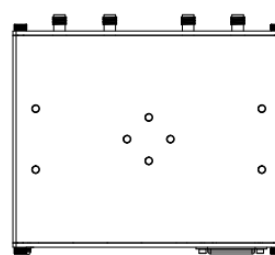

Side View

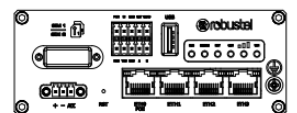
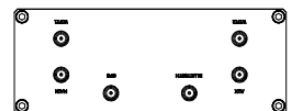

Top&Bottom View

1.5 Ordering Information

Model	R2110-4L	
Router Type	LTE Router	LTE-A Router
Air Interface	LTE/WCDMA/HSDPA/HSUPA/HSPA+/DC-HSPA+/TD-SCDMA/CDMA(CDMA 1X/EVDO)	LTE-A/LTE/WCDMA/HSDPA/HSUPA/HSPA+/DC-HSPA+/TD-SCDMA
Frequency Bands	AU:B1/B3/B5/B7/B8/B28/B40 EU:B1/B3/B7/B8/B20/B28/B31/B38/B40 US:B2/B4/B5/B13/B17/B25/B41 JP:B1/B3/B8/B9/B18/B19/B21/B28/B41 CN:B1/B3/B38/B39/B40/B41	APAC:B1/B3/B5/B7/B8/B18/B19/B21/B28/B38-B41 NA/EMEA:B1-B5/B7/B8/B12/B13/B20/B25/B26/B29/B30/B41
4G		
3G	WCDMA/HSDPA/HSUPA/HSPA+/DC-HSPA+:B1/B2/B5/B6/B8/B9/B19 TD-SCDMA:B34/B39 CDMA(CDMA 1X/EVDO):R0/A BC0/BC1/BC10	WCDMA/HSDPA/HSUPA/HSPA+/DC-HSPA+:B1-B6/B8/B9/B19 TD-SCDMA:B34/B39
2G	850/900/1800/1900 MHz	850/900/1800/1900 MHz
Operating Temperature	Normal operation: -20 to +55 °C Extended operation: -25 to +70 °C	Normal operation: -20 to +55 °C Extended operation: -25 to +70 °C
Storage Temperature	-40~+85 °C	-40~+85 °C
Relative Humidity	5~95% RH	5~95% RH

*For more information about frequency bands in different countries, please contact your Robustel sales representative.

Chapter 2 Hardware Installation

2.1 Definition of 2*5 3.5mm Interface

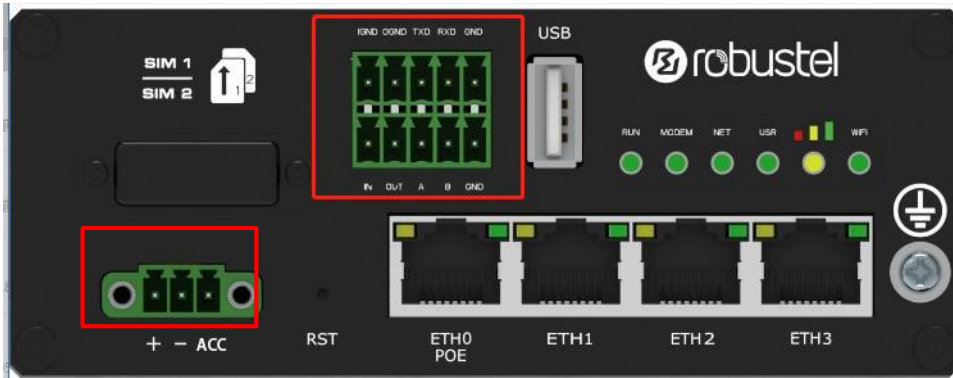

PIN	DI/DO	RS-232	RS-485	Direction
1	IGND	--	--	Router ← Device
2	OGND	--	--	Router → Device
3	--	TXD	--	--
4	--	RXD	--	Router → Device
5	--	GND	--	Router ← Device
6	IN	--	--	Router → Device
7	OUT	--	--	Router ← Device
8	--	--	A	--
9	--	--	B	--
10	--	--	GND	--

2.2 Definition of Power Interface

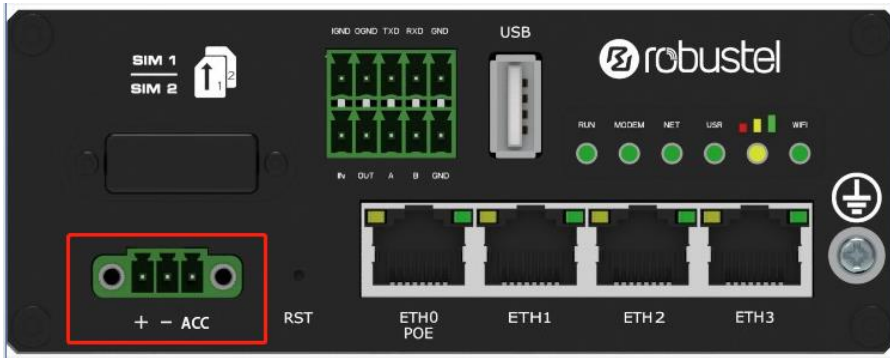

PIN	Power	Note
1	Positive	
2	Negative	
3	ACC	Car ignition and flameout detection

2.3 LED Indicators

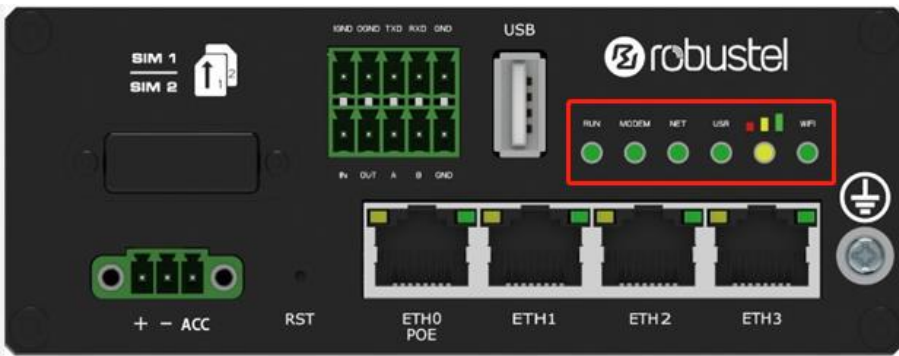

Name	Color	Status	Description
RUN	Green	On, solid	Router is powered on (System is initializing)
		On, blinking	Router starts operating
		Off	Router is powered off
MODEM	Green	On, solid	Link connection is working
		On, blinking	Data is sent and received.
		Off	Link connection is not working
NET	Green	On, solid	Connection to 4G network is established
		On, blinking	Connection to Legacy network (3G or 2G) is established
		Off	Network is not joined or joining
USR-OpenVPN	Green	On, solid	OpenVPN connection is established
		Off	OpenVPN connection is not established
USR-IPsec	Green	On, solid	IPsec connection is established
		Off	IPsec connection is not established

	Green	On, solid	Non-HL7539 module
	Yellow	On, solid	Signal level: HL7539 module: 3-9 dB (Moderate signal) Non-HL7539 module : 11-20 dB (Moderate signal)
	Red	On, solid	Signal level: HL7539 module: 1-2 dB (Low signal) Non-HL7539 module : 1-10 dB (Low signal)
	--	Off	Very Low Signal strength (0) is available or No signal
WiFi	Green	On, solid	WiFi is enabled and working properly
		Off	WiFi is disabled or not working properly

Note: You can choose the display type of USR LED. For more details, please refer to **Service > Advanced > System >System Setting > Custom LED light type.**

2.4 USB Interface



Function	Operation
Firmware upgrade	USB interface is used for batch firmware upgrading, but cannot be used for sending or receiving data from slave devices which connected to it. You can insert a USB storage device into the router’s USB interface, such as a U disk or a hard disk. If there have a supported configuration file or a router firmware in this USB storage device, the router will automatically update the configuration file or the firmware. For more details, see 3.11 Interface > USB.

2.5 Reset Button

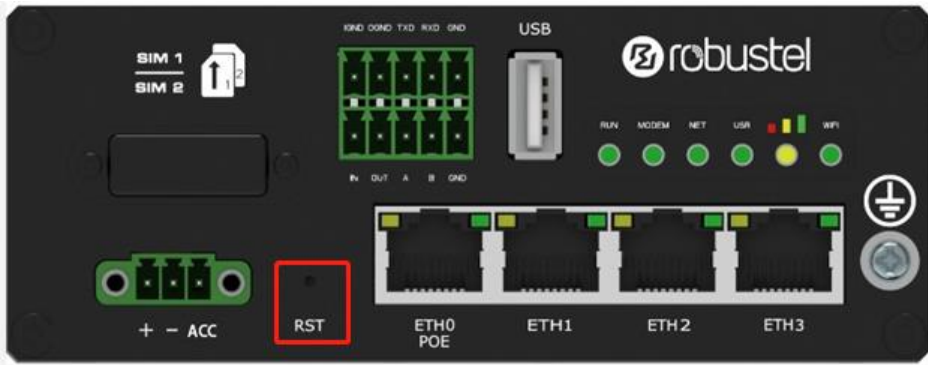

Function	Operation
Reboot	Press and hold the RST button for at least 5 seconds under the operating status.
Restore to factory default settings	Wait for 0~20 seconds after powering up the router, press and hold the RST button with a pointed stick until all six LEDs start blinking one by one, and release the button to return the router to factory defaults.

2.6 Ethernet Ports



There are four Ethernet ports on R2110-4L, including ETH0 (POE), ETH1, ETH2, ETH3. Each has two LED indicators. The yellow one is a link indicator but the green one doesn't mean anything. For details about status, see the table below.

Indicator	Status	Description
Link indicator (Yellow)	On, solid	Connection is established
	On, blinking	Data is being transferred
	Off	Connection is not established

2.7 Insert or Remove SIM Card

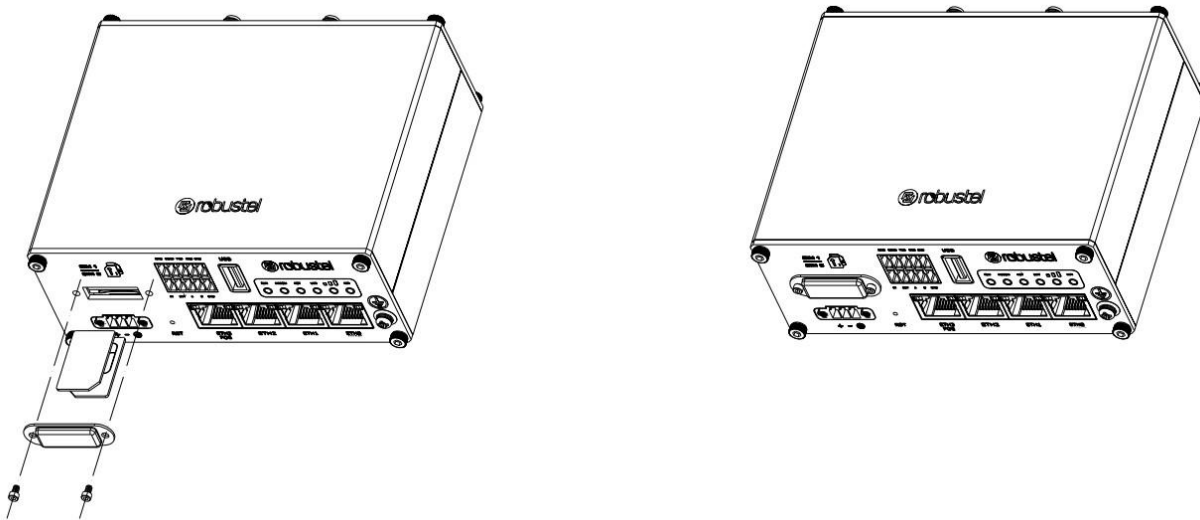
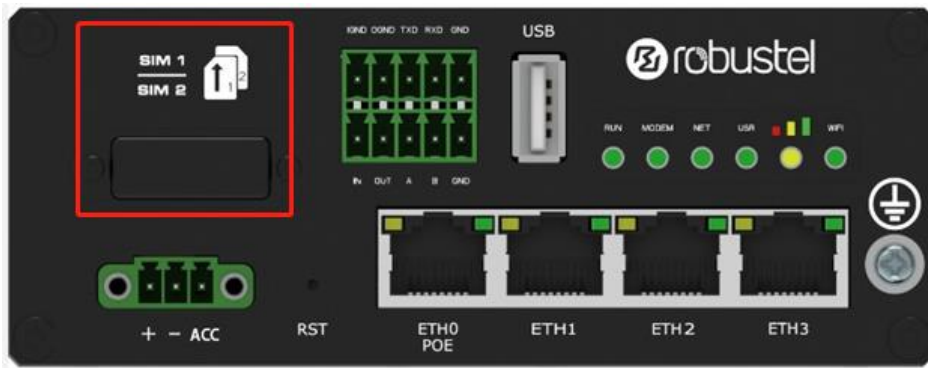

Insert or remove the SIM card as shown in the following steps.

- **Insert SIM card**

1. Make sure router is powered off.
2. To remove slot cover, loosen the screws associated with the cover by using a screwdriver and then find the SIM card slot.
3. To insert SIM card, press the card with finger until you hear a click and then tighten the screws associated with the cover by using a screwdriver.
4. To put back the cover and tighten the screws associated with the cover by using a screwdriver.

- **Remove SIM card**

1. Make sure router is powered off.
2. To remove slot cover, loosen the screws associated with the cover by using a screwdriver and then find the SIM card slot.
3. To remove SIM card, press the card with finger until it pops out and then take out the card.
4. To put back the cover and tighten the screws associated with the cover by using a screwdriver.

Note:

1. Use the specific card when the device is working in extreme temperature (temperature exceeding 40 °C), because the regular card for long-time working in harsh environment will be disconnected frequently.

2. Do not forget to twist the cover tightly to avoid being stolen.
3. Do not touch the metal of the card surface in case information in the card will lose or be destroyed.
4. Do not bend or scratch the card.
5. Keep the card away from electricity and magnetism.
6. Make sure router is powered off before inserting or removing the card.

2.8 Attach External Antenna (SMA Type)

Attach an external SMA antenna to the router’s antenna connector and twist tightly. Make sure the antenna is within the correct frequency range provided by the ISP and with 50 Ohm impedance.

Note: Recommended torque for tightening is 0.35 N.m.

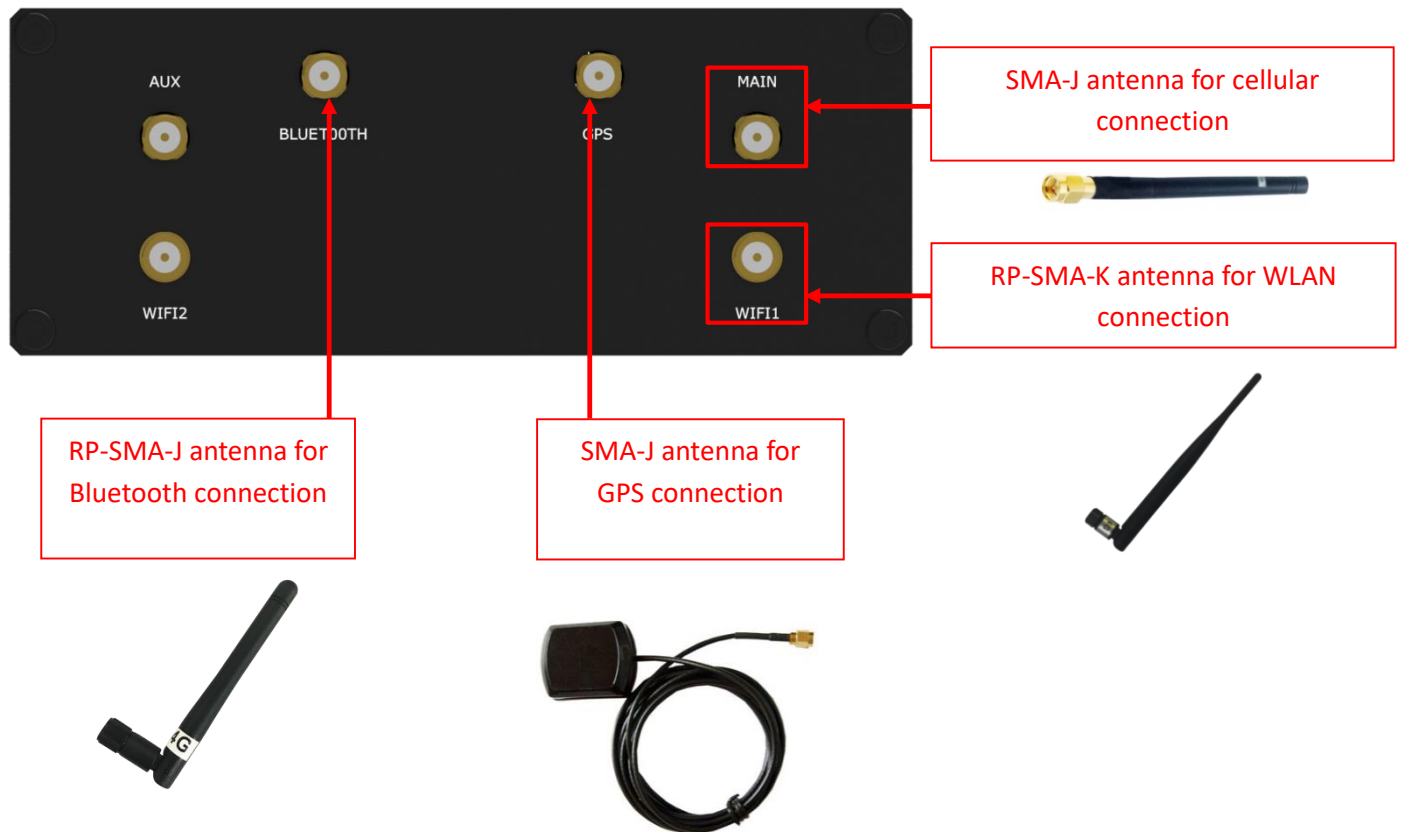

2.9 Mount the Router

The router can be placed on a desktop or mounted to a wall or a 35 mm DIN rail.

Two methods for mounting the router

1. Wall mounting (measured in mm)

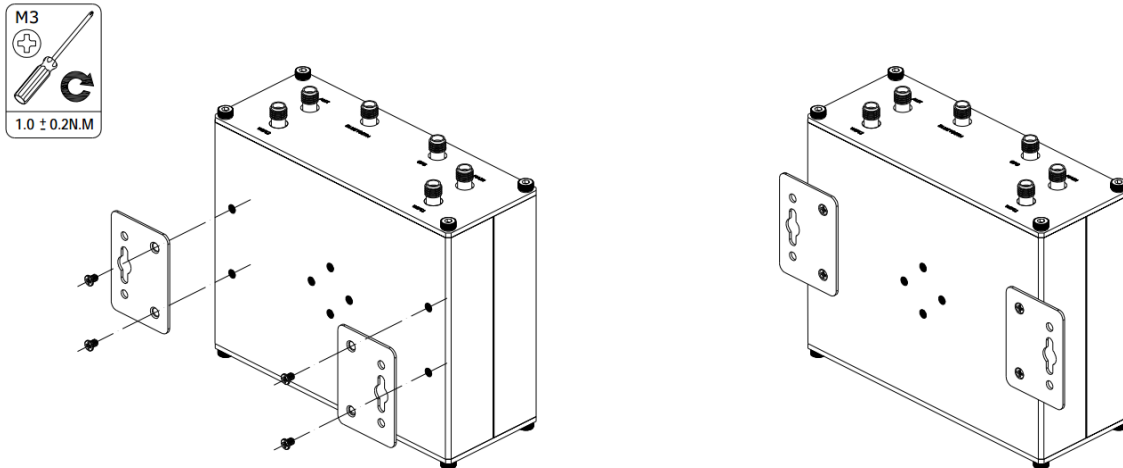

Use 4 pcs of M2.5*4 flat head Phillips screws to fix the wall mounting kit to the router, and then use 2 pcs of M3 drywall screws to mount the router associated with the wall mounting kit on the wall.

Note: Recommended torque for mounting is 1.0 N.m, and the maximum allowed is 1.2 N.m.

2. DIN rail mounting (measured in mm)

- Option 1

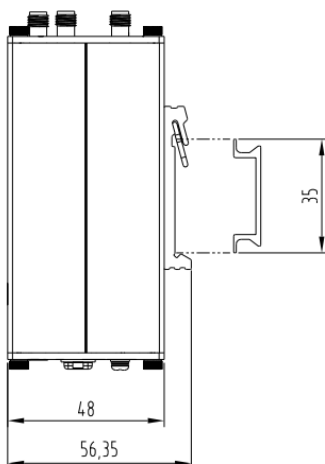

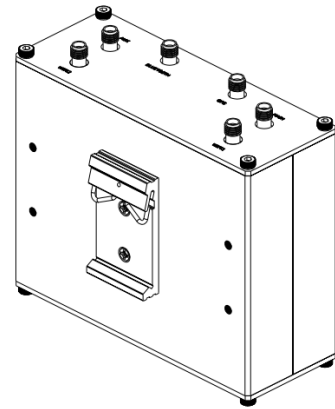
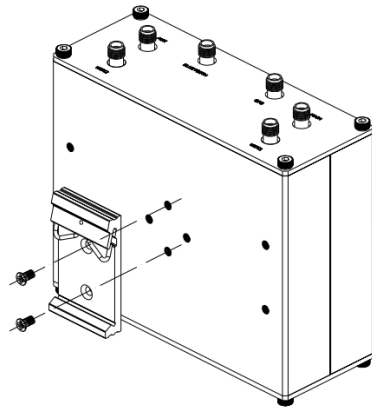

Use 2 pcs of M3*6 stainless flat head Phillips screws to fix the DIN rail to the router, and then hang the DIN rail on the mounting bracket. It is necessary to choose a standard bracket.

Note: Recommended torque for mounting is 1.0 N.m, and the maximum allowed is 1.2 N.m.

- Option 2

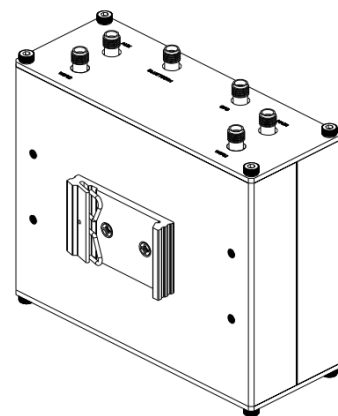
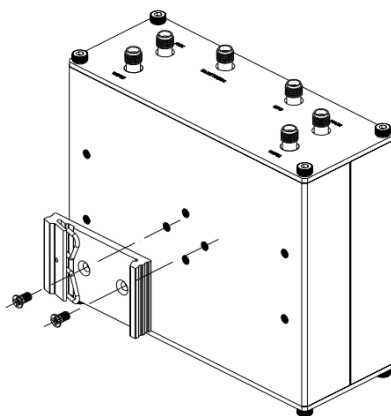
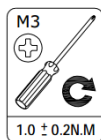
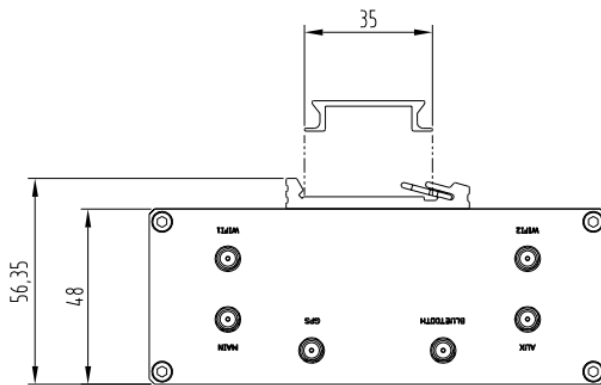

Use 2 pcs of M3*6 stainless flat head Phillips screws to fix the DIN rail to the router, and then hang the DIN rail on the mounting bracket. It is necessary to choose a standard bracket.

Note: Recommended torque for mounting is 1.0 N.m, and the maximum allowed is 1.2 N.m.

2.10 Ground the Router

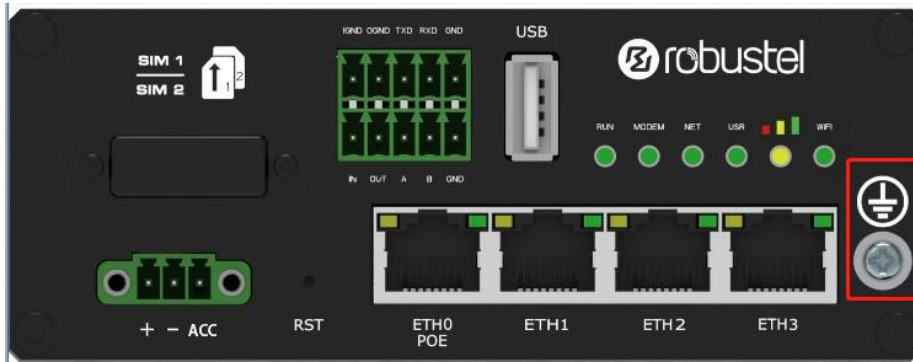

Router grounding helps prevent the noise effect due to electromagnetic interference (EMI). Connect the router to the site ground wire by the ground screw before powering on.

Note: This product is appropriate to be mounted on a sound grounded device surface, such as a metal panel.

2.11 Connect the Router to a Computer

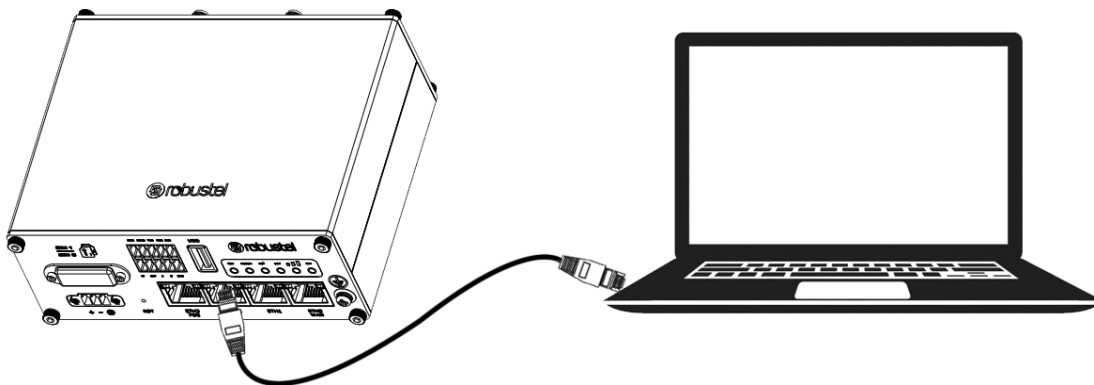

Connect an Ethernet cable to the port marked ETH1~ETH3 at the front of the R2110 Router, and connect the other end of the cable to your computer.

2.12 Power Supply

With Ignition Sensing

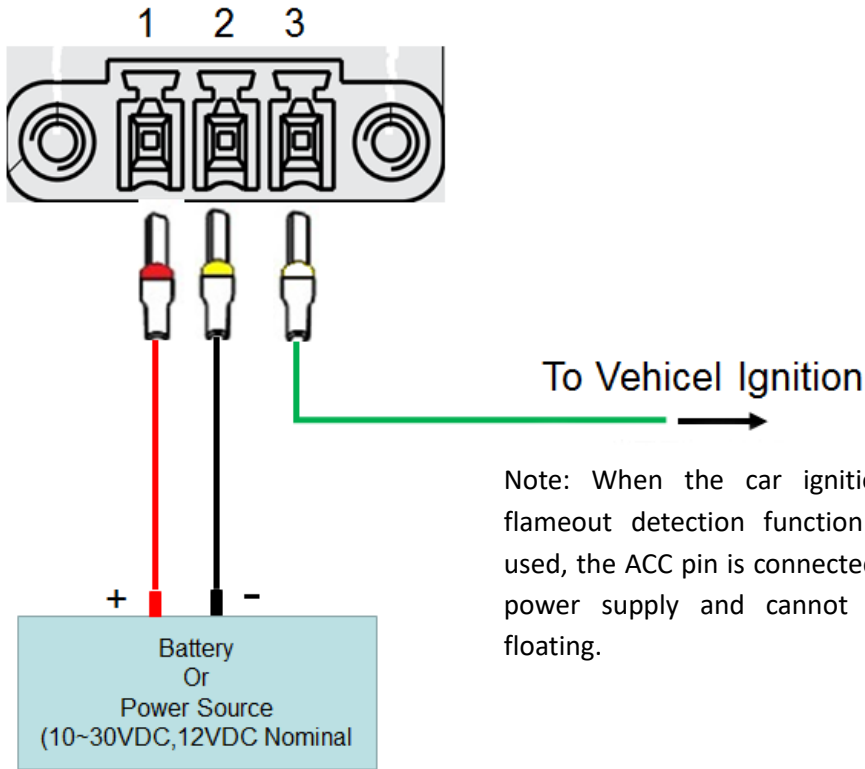

Note: When the car ignition and flameout detection function is not used, the ACC pin is connected to the power supply and cannot be left floating.

PIN	Description	Note
1	V+	Connect adapter or battery positive (red line)
2	V-	Connect adapter or battery negative (black)
3	ACC	Car ignition and flameout detection (green line), when the car ignition and flameout detection function is not used, the ACC pin is connected to the power supply and cannot be left floating.

With POE Function

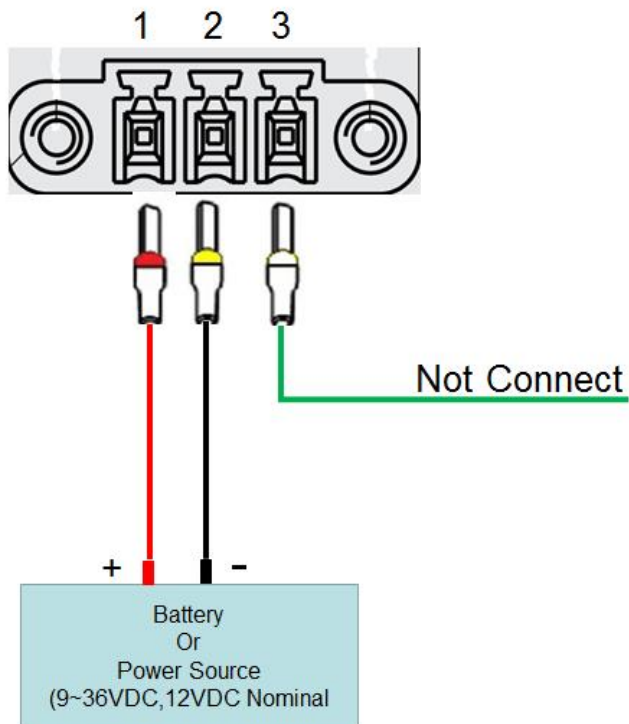

PIN	Description	Note
1	V+	Connect adapter or battery positive (red line)
2	V-	Connect adapter or battery negative (black)
3	Not connected	

Note:

- The Input voltage is: 10 to 30V DC(With ignition sensing)
9 to 36V DC (Without ignition sensing)
- The car ignition sensing function and the POE function can only be selected one by one.

Chapter 3 Initial Configuration

The router can be configured through your web browser that including IE 8.0 or above, Chrome and Firefox, etc. A web browser is included as a standard application in the following operating systems: Linux, Mac OS, Windows 98/NT/2000/XP/Me/Vista/7/8, etc. It provides an easy and user-friendly interface for configuration. There are various ways to connect the router, either through an external repeater/hub or connect directly to your PC. However, make sure that your PC has an Ethernet interface properly installed prior to connecting the router. You must configure your PC to obtain an IP address through a DHCP server or a fixed IP address that must be in the same subnet as the router. If you encounter any problems accessing the router web interface, it is advisable to uninstall your firewall program on your PC, as this tends to cause problems accessing the IP address of the router.

3.1 Configure the PC

There are two methods to get IP address for the PC. One is to obtain an IP address automatically from “Local Area Connection”, and another is to configure a static IP address manually within the same subnet of the router. Please refer to the steps below.

Here take **Windows 7** as example, and the configuration for windows system is similar.

1. Click **Start > Control panel**, double-click **Network and Sharing Center**, and then double-click **Local Area Connection**.

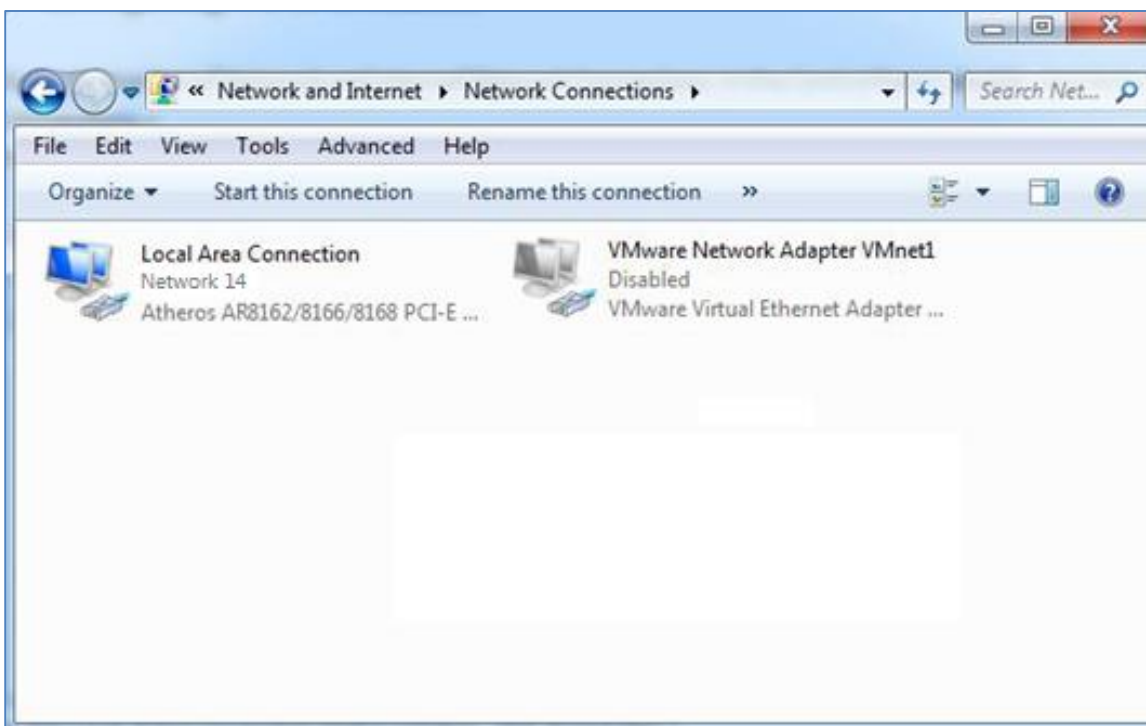

2. Click **Properties** in the window of **Local Area Connection Status**.

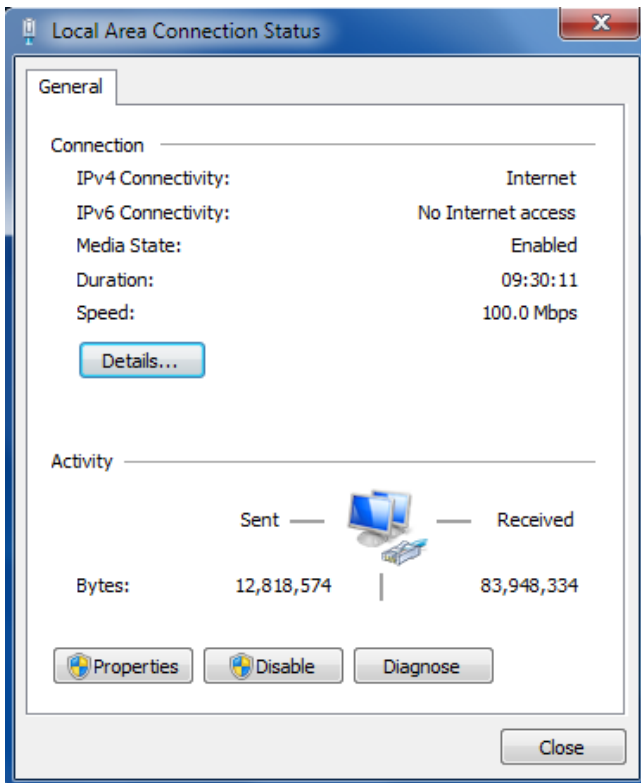

3. Choose **Internet Protocol Version 4 (TCP/IPv4)** and click **Properties**.

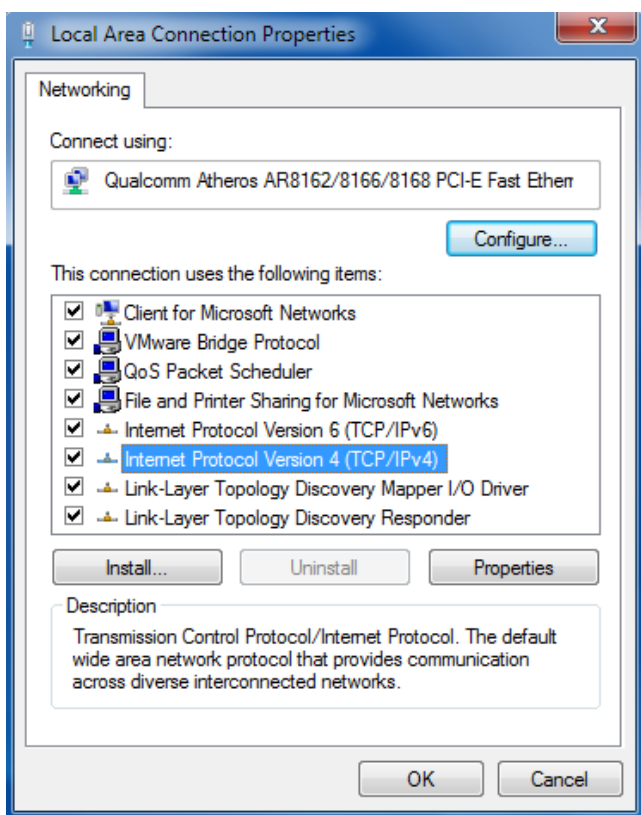

4. Two ways for configuring the IP address of PC

Obtain an IP address automatically from the DHCP server and click "Obtain an IP address automatically";

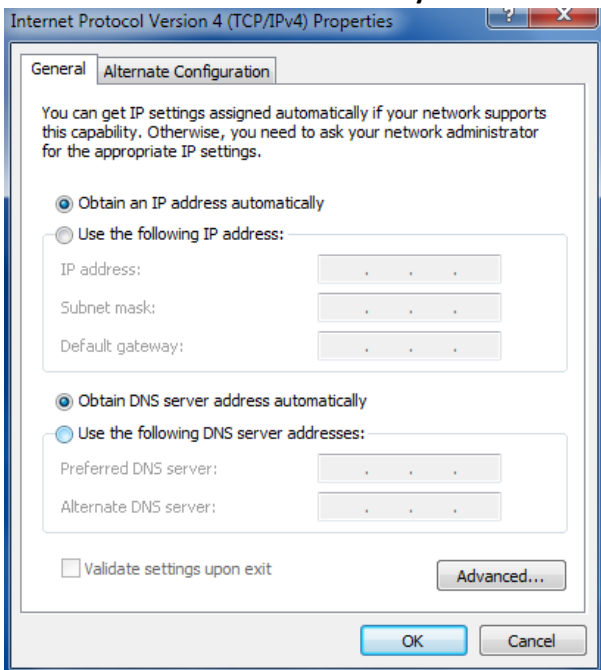

Use the following IP address:

(Configured a static IP address manually within the same subnet of the router. Click and configure "Use the following IP address.")

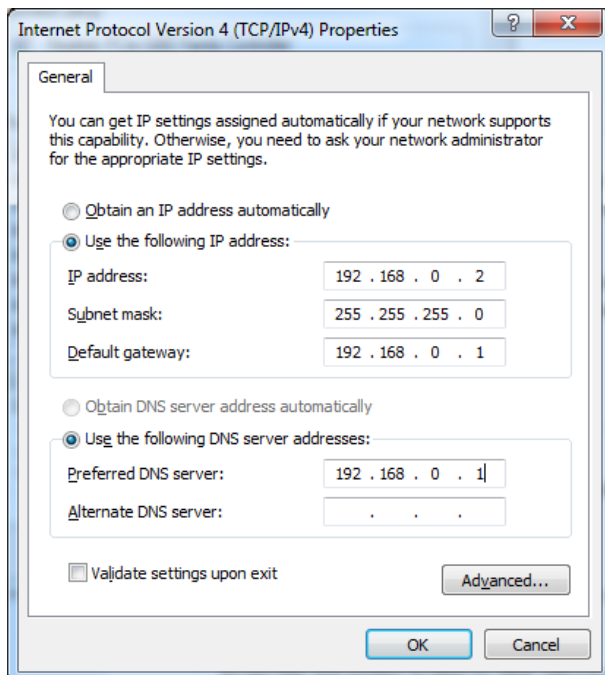

5. Click **OK** to finish the configuration.

3.2 Factory Default Settings

Before configuring your router, you need to know the following default settings.

Item	Description
Username	admin
Password	admin
ETH0/POE	192.168.0.1/255.255.255.0, WAN mode
ETH1	192.168.0.1/255.255.255.0, LAN mode
ETH2	192.168.0.1/255.255.255.0, LAN mode
ETH3	192.168.0.1/255.255.255.0, LAN mode
DHCP Server	Enabled

3.3 Log in the Router

To log in to the management page and view the configuration status of your router, please follow the steps below.

1. On your PC, open a web browser such as Internet Explorer, Google and Firefox, etc.
2. From your web browser, type the IP address of the router into the address bar and press enter. The default IP address of the router is 192.168.0.1, though the actual address may vary.

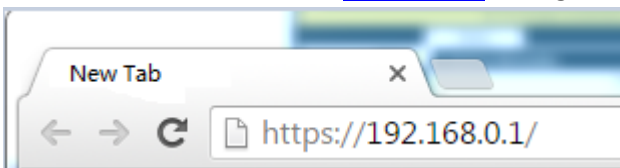

3. In the login page, enter the username and password, choose language and then click **LOGIN**. The default username and password are "admin".

Note: If enter the wrong username or password over six times, the login web will be locked for 5 minutes.

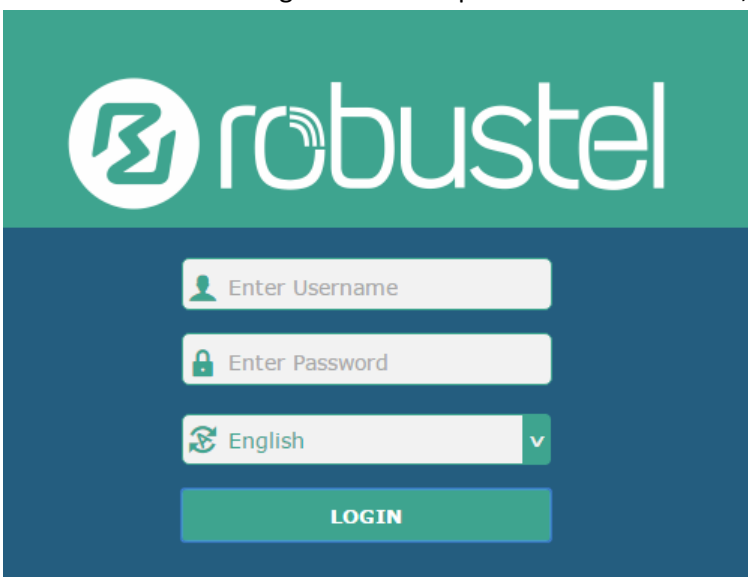

3.4 Control Panel

After logging in, the home page of the R2110 Router’s web interface is displayed, for example.

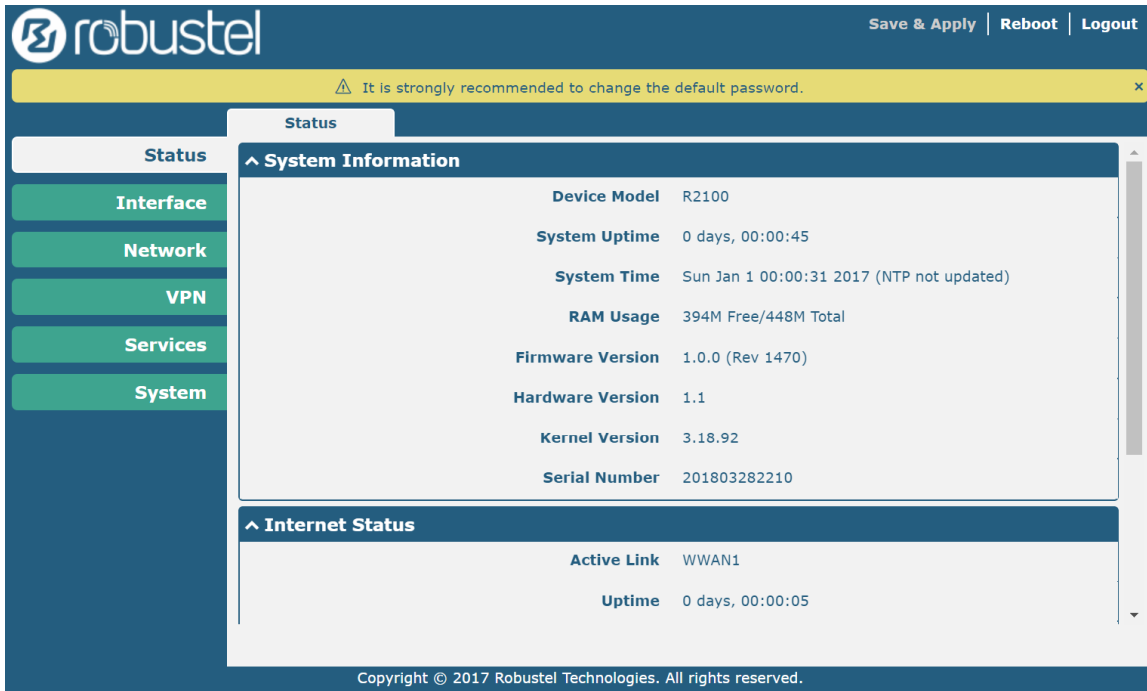

In the home page, users can perform operations such as saving the configuration, restarting the router, and logging out.

Using the original password to log in the router, the page will pop up the following tab



Click the **X** symbol to close the popup. It is strongly recommended for security purposes that you change the default username and/or password. To change your username and/or password, see **3.34 System > User Management**.

Control Panel		
Item	Description	Button
Save & Apply	Click to save the current configuration into router’s flash and apply the modification on every configuration page, to make the modification taking effect.	
Reboot	Click to reboot the router. If the Reboot button is yellow, it means that some completed configurations will take effect only after reboot.	
Logout	Click to log the current user out safely. After logging out, it will switch to login page. Shut down web page directly without logout, the next one can login web on this browser without a password before timeout.	
Submit	Click to save the modification on current configuration page.	
Cancel	Click to cancel the modification on current configuration page.	

Note: The steps of how to modify configuration are as bellow:

1. Modify in one page;
2. Click **Submit** under this page;
3. Modify in another page;
4. Click **Submit** under this page;
5. Complete all modification;
6. Click **Save & Apply**.

3.5 Status

This page allows you to view the System Information, Internet Status and LAN Status of your Router.

System Information

This section shows the system status information of your Router.

^ System Information	
Device Model	R2110
System Uptime	0 days, 00:07:29
System Time	Wed Mar 28 20:28:56 2018
RAM Usage	395M Free/448M Total
Firmware Version	1.0.0 (Rev 1470)
Hardware Version	1.1
Kernel Version	3.18.92
Serial Number	201803282210

System Information	
Item	Description
Device Model	Show the model name of your device.
System Uptime	Show the current amount of time the router has been connected.
System Time	Show the current system time.
RAM Usage	Show the free memory and the total memory.
Firmware Version	Show the firmware version running on the router.
Hardware Version	Show the current hardware version.
Kernel Version	Show the current kernel version.
Serial Number	Show the serial number of your device.

Cellular Status

This section shows the cellular status information of the router.

^ Internet Status	
Active Link	WWAN1
Uptime	0 days, 00:39:31
IP Address	10.122.74.11/255.255.255.248
Gateway	10.122.74.9
DNS	210.21.4.130 221.5.88.88

Cellular Status	
Item	Description
Active Link	Show the current active link. WWAN1, WWAN2 or WAN.
Uptime	Show the current amount of time the link has been connected.
IP Address	Show the IP address of current link.
Router	Show the router address of the current link.
DNS	Show the current primary DNS server and secondary server.

Internet Status

This section shows the Internet status information of the router.

^ LAN Status	
IP Address	172.16.24.24/255.255.0.0
MAC Address	34:FA:40:07:38:91

Internet Status	
Item	Description
IP Address	Show the IP address and the Netmask of the router.
MAC Address	Show the MAC address of the router.

3.6 Interface > Link Manager

This section allows you to setup the link connection. Link management is a network link backup feature that provides backup of mobile networks and Ethernet links.

Link Manager
Status

^ General Settings

Primary Link ?

Backup Link

Backup Mode ?

Revert Interval ?

Emergency Reboot OFF ?

General Settings @ Link Manager		
Item	Description	Default
Primary Link	Select from "WWAN1", "WWAN2", "WAN" or "WLAN". <ul style="list-style-type: none"> WWAN1: Select SIM1 as the primary wireless link WWAN2: Select SIM2 as the primary wireless link WAN: Select WAN as the primary wired link WLAN: Select WLAN as the primary wireless link Note: WLAN link is available only if enable WiFi as Client mode, please refer to 3.10 Interface > WiFi (Optional) .	WWAN1
Backup Link	Select from "None", "WWAN1", "WWAN2", "WAN", "WLAN" or "None". <ul style="list-style-type: none"> WWAN1: Select SIM1 as backup wireless link WWAN2: Select SIM2 as backup wireless link WAN: Select WAN as the backup wired link WLAN: Select to make WLAN as the backup wireless link Note: WLAN link is available only if enable WiFi as Client mode, please refer to 3.10 Interface > WiFi (Optional) . <ul style="list-style-type: none"> None: Do not select any backup link 	WWAN2
Backup Mode	Select from "Cold Backup", "Warm Backup" or "Load Balancing". <ul style="list-style-type: none"> Cold Backup: The inactive link is offline on standby Warm Backup: The inactive link is online on standby Note: Warm backup mode is not available for dual SIM backup. <ul style="list-style-type: none"> Load Balancing: Use two links simultaneously 	Cold Backup
Revert Interval	Specify the number of minutes that elapses before the primary link is checked if a backup link is being used in cold backup mode. 0 means disable checking. Note: Revert interval is available only under the cold backup mode.	0
Emergency Reboot	Click the toggle button to enable/disable this option. Enable to reboot the whole system if no links available.	OFF

Note: Click  for help.

Link Settings allows you to configure the parameters of link connection, including WWAN1/WWAN2, WAN and WLAN. It is recommended to enable Ping detection to keep the router always online. The Ping detection increases the reliability and also costs the data traffic.

^ Link Settings				
Index	Type	Description	Connection Type	
1	WWAN1		DHCP	
2	WWAN2		DHCP	
3	WAN		DHCP	
4	WLAN		DHCP	

Click on the right-most of WWAN1/WWAN2 to enter the configuration window.

WWAN1/WWAN2

Link Manager

^ General Settings

Index

Type

Description

The window is displayed as below when enabling the “Automatic APN Selection” option.

^ WWAN Settings

Automatic APN Selection ON OFF

Dialup Number

Authentication Type

Switch SIM By Data Allowance ON OFF ?

Data Allowance ?

Billing Day ?

The window is displayed as below when disabling the “Automatic APN Selection” option.

^ WWAN Settings

Automatic APN Selection ON OFF

APN

Username

Password

Dialup Number

Authentication Type

Switch SIM By Data Allowance ON OFF ?

Data Allowance ?

Billing Day ?

^ Ping Detection Settings
?

Enable ON OFF

Primary Server

Secondary Server

Interval ?

Retry Interval ?

Timeout ?

Max Ping Tries ?

^ Advanced Settings

NAT Enable ON OFF

Upload Bandwidth ?

Download Bandwidth

Overridden Primary DNS

Overridden Secondary DNS

Debug Enable ON OFF

Verbose Debug Enable ON OFF

Link Settings (WWAN)		
Item	Description	Default
General Settings		
Index	Indicate the ordinal of the list.	--
Type	Show the type of the link.	WWAN1
Description	Enter a description for this link.	Null
WWAN Settings		
Automatic APN Selection	Click the toggle button to enable/disable the "Automatic APN Selection" option. After enabling, the device will recognize the access point name automatically. Alternatively, you can disable this option and manually add the access point name.	ON
APN	Enter the Access Point Name for cellular dial-up connection, provided by local ISP.	internet
Username	Enter the username for cellular dial-up connection, provided by local ISP.	Null
Password	Enter the password for cellular dial-up connection, provided by local ISP.	Null
Dialup Number	Enter the dialup number for cellular dial-up connection, provided by local ISP.	*99***1#
Authentication Type	Select from "Auto", "PAP" or "CHAP" as the local ISP required.	Auto
Switch SIM By Data Allowance	Click the toggle button to enable/disable this option. After enabling, it will switch to another SIM when the data limit reached. Note: Only used for dual SIM backup.	OFF

Link Settings (WWAN)		
Item	Description	Default
Data Allowance	Set the monthly data traffic limitation. The system will record the data traffic statistics when data traffic limitation (MiB) is specified. The traffic record will be displayed in Interface > Link Manager > Status > WWAN Data Usage Statistics . 0 means disable data traffic record.	0
Billing Day	Specify the monthly billing day. The data traffic statistics will be recalculated from that day.	1
Ping Detection Settings		
Enable	Click the toggle button to enable/disable the ping detection mechanism, a keep-alive policy of the router.	ON
Primary Server	Router will ping this primary address/domain name to check that if the current connectivity is active.	8.8.8.8
Secondary Server	Router will ping this secondary address/domain name to check that if the current connectivity is active.	114.114.114.114
Interval	Set the ping interval.	300
Retry Interval	Set the ping retry interval. When ping failed, the router will ping again every retry interval.	5
Timeout	Set the ping timeout.	3
Max Ping Tries	Set the max ping tries. Switch to another link or take emergency action if the max continuous ping tries reached.	3
Advanced Settings		
NAT Enable	Click the toggle button to enable/disable the Network Address Translation option.	ON
Upload Bandwidth	Set the upload bandwidth used for QoS, measured in kbps.	10000
Download Bandwidth	Set the download bandwidth used for QoS, measured in kbps.	10000
Overridden Primary DNS	Override primary DNS will override the automatically obtained DNS.	Null
Overridden Secondary DNS	Override secondary DNS will override the automatically obtained DNS.	Null
Debug Enable	Click the toggle button to enable/disable this option. Enable for debugging information output.	ON
Verbose Debug Enable	Click the toggle button to enable/disable this option. Enable for verbose debugging information output.	OFF

WAN

Router will obtain IP automatically from DHCP server if choosing “DHCP” as connection type. The window is displayed as below.

Link Manager

^ **General Settings**

Index

Type

Description

Connection Type

The window is displayed as below when choosing “Static” as the connection type.

^ **General Settings**

Index

Type

Description

Connection Type

^ **Static Address Settings**

IP Address ?

Gateway

Primary DNS

Secondary DNS

The window is displayed as below when choosing “PPPoE” as the connection type.

^ **General Settings**

Index

Type

Description

Connection Type

^ **PPPoE Settings**

Username

Password

Authentication Type

PPP Expert Options ?

^ Ping Detection Settings
?

Enable ON OFF

Primary Server

Secondary Server

Interval ?

Retry Interval ?

Timeout ?

Max Ping Tries ?

^ Advanced Settings

NAT Enable ON OFF

MTU

Upload Bandwidth ?

Download Bandwidth

Overridden Primary DNS

Overridden Secondary DNS

Debug Enable ON OFF

Verbose Debug Enable ON OFF

Link Settings (WAN)		
Item	Description	Default
General Settings		
Index	Indicate the ordinal of the list.	--
Type	Show the type of the link.	WAN
Description	Enter a description for this link.	Null
Connection Type	Select from "DHCP", "Static" or "PPPoE".	DHCP
Static Address Settings		
IP Address	Set the IP address with Netmask which can access the internet. IP address with Netmask, e.g. 192.168.1.1/24	Null
Router	Set the router of the IP address in WAN port.	Null
Primary DNS	Set the primary DNS.	Null
Secondary DNS	Set the secondary DNS.	Null
PPPoE Settings		
Username	Enter the username provided by your Internet Service Provider.	Null
Password	Enter the password provided by your Internet Service Provider.	Null
Authentication Type	Select from "Auto", "PAP" or "CHAP" as the local ISP required.	Auto
PPP Expert Options	Enter the PPP Expert options used for PPPoE dialup. You can enter some other PPP dial strings in this field. Each string can be separated by a semicolon.	Null
Ping Detection Settings		

Enable	Click the toggle button to enable/disable the ping detection mechanism, a keep-alive policy of the router.	ON
Primary Server	Router will ping this primary address/domain name to check that if the current connectivity is active.	8.8.8.8
Secondary Server	Router will ping this secondary address/domain name to check that if the current connectivity is active.	114.114.1 14.114
Interval	Set the ping interval.	300
Retry Interval	Set the ping retry interval. When ping failed, the router will ping again every retry interval.	5
Timeout	Set the ping timeout.	3
Max Ping Tries	Set the max ping tries. Switch to another link or take emergency action if the max continuous ping tries reached.	3
Advanced Settings		
NAT Enable	Click the toggle button to enable/disable the Network Address Translation option.	ON
MTU	Enter the Maximum Transmission Unit.	1500
Upload Bandwidth	Enter the upload bandwidth used for QoS, measured in kbps.	10000
Download Bandwidth	Enter the download bandwidth used for QoS, measured in kbps.	10000
Overridden Primary DNS	Override primary DNS will override the automatically obtained DNS.	Null
Overridden Secondary DNS	Override secondary DNS will override the automatically obtained DNS.	Null
Debug Enable	Click the toggle button to enable/disable this option. Enable for debugging information output.	ON
Verbose Debug Enable	Click the toggle button to enable/disable this option. Enable for verbose debugging information output.	OFF

WLAN

Router will obtain IP automatically from the WLAN AP if choosing “DHCP” as the connection type. The specific parameter configuration of SSID is shown as below.

Link Manager

^ **General Settings**

Index

Type

Description

Connection Type

^ **WLAN Settings**

SSID

Connect to Hidden SSID OFF

Password

The window is displayed as below when choosing “Static” as the connection type.

^ **General Settings**

Index

Type

Description

Connection Type

v **WLAN Settings**

^ **Static Address Settings**

IP Address ?

Gateway

Primary DNS

Secondary DNS

R2100 does not support the **PPPoE** WLAN Connection Type.

^ **Ping Detection Settings** ?

Enable ON OFF

Primary Server

Secondary Server

Interval ?

Retry Interval ?

Timeout ?

Max Ping Tries ?

^ **Advanced Settings**

NAT Enable ON OFF

MTU

Upload Bandwidth ?

Download Bandwidth

Overrided Primary DNS

Overrided Secondary DNS

Debug Enable ON OFF

Verbose Debug Enable ON OFF

Link Settings (WLAN)		
Item	Description	Default
General Settings		
Index	Indicate the ordinal of the list.	--

Type	Show the type of the link.	WLAN
Description	Enter a description for this link.	Null
Connection Type	Select from "DHCP" or "Static".	DHCP
WLAN Settings		
SSID	Enter a 1-32 characters SSID which your router wants to connect. SSID (Service Set Identifier) is the name of your wireless network.	router
Connect to Hidden SSID	Click the toggle button to enable/disable this option. When router works as Client mode and needs to connect any access point which has hidden SSID, you need to enable this option.	OFF
Password	Enter an 8-63 characters password of the access point which your router wants to connect.	Null
Static Address Settings		
IP Address	Enter the IP address with Netmask which can access the Internet, e.g. 192.168.1.1/24	Null
Router	Enter the IP address of WiFi AP.	Null
Primary DNS	Set the primary DNS.	Null
Secondary DNS	Set the secondary DNS.	Null
Ping Detection Settings		
Enable	Click the toggle button to enable/disable the ping detection mechanism, a keepalive policy of the router.	ON
Primary Server	Router will ping this primary address/domain name to check that if the current connectivity is active.	8.8.8.8
Secondary Server	Router will ping this secondary address/domain name to check that if the current connectivity is active.	114.114.114.114
Interval	Set the ping interval.	300
Retry Interval	Set the ping retry interval. When ping failed, the router will ping again every retry interval.	5
Timeout	Set the ping timeout.	3
Max Ping Tries	Set the max ping tries. Switch to another link or take emergency action if the max continuous ping tries reached.	3
Advance Settings		
NAT Enable	Click the toggle button to enable/disable the Network Address Translation option.	ON
MTU	Enter the Maximum Transmission Unit.	1500
Upload Bandwidth	Enter the upload bandwidth used for QoS, measured in kbps.	10000
Download Bandwidth	Enter the download bandwidth used for QoS, measured in kbps.	10000
Overridden Primary DNS	Override primary DNS will override the automatically obtained DNS.	Null
Overridden Secondary DNS	Override secondary DNS will override the automatically obtained DNS.	Null
Debug Enable	Click the toggle button to enable/disable this option. Enable for debugging information output.	ON
Verbose Debug Enable	Click the toggle button to enable/disable this option. Enable for verbose debugging information output.	OFF

Status

This page allows you to view the status of link connection and clear the monthly data usage statistics.

Link Manager		Status		
^ Link Status ...				
Index	Link	Status	Uptime	IP Address
1	WWAN1	Connected	0 days, 01:03:29	10.122.74.11..
2	WWAN2	Disconnected		

Click the right-most button ... to select the connection status of the current link.

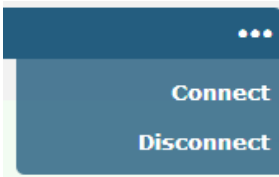

Click the row of the link, and it will show the details information of the current link connection under the row.

Link Manager		Status		
^ Link Status ...				
Index	Link	Status	Uptime	IP Address
1	WWAN1	Connected	0 days, 01:03:29	10.122.74.11..
Index 1 Link WWAN1 Status Connected Interface wwan Uptime 0 days, 01:03:29 IP Address 10.122.74.11/255.255.255.248 Gateway 10.122.74.9 DNS 210.21.4.130 221.5.88.88 RX Packets 42 TX Packets 46 RX Bytes 2962 TX Bytes 3568				
2	WWAN2	Disconnected		

^ WWAN Data Usage Statistics	
WWAN1 Monthly Stats	Clear
WWAN2 Monthly Stats	Clear

Click the Clear button to clear SIM1 or SIM2 monthly data traffic usage statistics. Data statistics will be displayed

only if enable the Data Allowance function in **Interface > Link Manager > Link Settings > WWAN Settings > Data Allowance**.

3.7 Interface > LAN

This section allows you to set the related parameters for LAN port. There are three LAN ports on R2110 Router, including ETH1, ETH2 and ETH3. The ETH1, ETH2 and ETH3 can freely choose from lan0, lan1 and lan2, but at least one LAN port must be assigned as lan0. The default settings of ETH1, ETH2 and ETH3 are lan0 and their default IP are 192.168.0.1/255.255.255.0.

LAN

By default, there is a LAN port (lan0) in the list. To begin adding a new LAN port (lan1), please configure ETH1, ETH2 or ETH3 as lan1 first in **Ethernet > Ports > Port Settings**. Otherwise, the operation will be prompted as “List is full”.

LAN	Multiple IP	Status		
^ Network Settings ?				
Index	Interface	IP Address	Netmask	+
1	lan0	192.168.0.1	255.255.255.0	✕

Note: Lan0 cannot be deleted.

You may click **+** to add a new LAN port, or click **✕** to delete the current LAN port. Now, click **✎** to edit the configuration of the LAN port.

LAN

^ General Settings

Index

Interface

IP Address

Netmask

MTU

General Settings @ LAN		
Item	Description	Default
Index	Indicate the ordinal of the list.	--
Interface	Show the editing port. Note: Lan1 is available only if it was selected by one of ETH1~ETH3 in Ethernet > Ports > Port Settings .	--
IP Address	Set the IP address of the LAN port.	192.168.0.1
Netmask	Set the Netmask of the LAN port.	255.255.255.0
MTU	Enter the Maximum Transmission Unit.	1500
VLAN ID	Enter the VLAN ID corresponding to the lan interface to divide the eth interface	0

in the same lan into the same vlan.

The window is displayed as below when choosing “Server” as the mode.

^ DHCP Settings

Enable ON OFF

Mode Server ▼

IP Pool Start

IP Pool End

Subnet Mask

^ DHCP Advanced Settings

Gateway

Primary DNS

Secondary DNS

WINS Server

Lease Time ?

Static lease ?

Expert Options ?

Debug Enable ON OFF

The window is displayed as below when choosing “Relay” as the mode.

^ DHCP Settings

Enable ON OFF

Mode Relay ▼

DHCP Server For Relay







^ DHCP Advanced Settings



Debug Enable ON OFF

LAN		
Item	Description	Default
DHCP Settings		
Enable	Click the toggle button to enable/disable the DHCP function.	ON
Mode	Select from “Server” or “Relay”. <ul style="list-style-type: none"> Server: Lease IP address to DHCP clients which have been connected to LAN port Relay: Router can be DHCP Relay, which will provide a relay tunnel to solve problem that DHCP Client and DHCP Server is not in a same subnet 	Server

LAN		
Item	Description	Default
IP Pool Start	Define the beginning of the pool of IP addresses which will be leased to DHCP clients.	192.168.0.2
IP Pool End	Define the end of the pool of IP addresses which will be leased to DHCP clients.	192.168.0.100
Subnet Mask	Define the subnet mask of IP address obtained by DHCP clients from DHCP server.	255.255.255.0
DHCP Server for Relay	Enter the IP address of DHCP relay server.	Null
DHCP Advanced Settings		
Router	Define the router assigned by the DHCP server to the clients, which must be on the same network segment with DHCP address pool.	Null
Primary DNS	Define the primary DNS server assigned by the DHCP server to the clients.	Null
Secondary DNS	Define the secondary DNS server assigned by the DHCP server to the clients.	Null
WINS Server	Define the Windows Internet Naming Service obtained by DHCP clients from DHCP sever.	Null
Lease Time	Set the lease time which the client can use the IP address obtained from DHCP server, measured in seconds.	120
Static lease	Bind a lease to correspond an IP address via a MAC address. format: mac,ip;mac,ip;..., e.g. FF:ED:CB:A0:98:01,192.168.0.200	Null
Expert Options	Enter some other options of DHCP server in this field. format: config-desc;config-desc, e.g. log-dhcp;quiet-dhcp	Null
Debug Enable	Click the toggle button to enable/disable this option. Enable for DHCP information output.	OFF

Multiple IP

LAN	Multiple IP	Status										
Multiple IP Settings <table border="1"> <thead> <tr> <th>Index</th> <th>Interface</th> <th>IP Address</th> <th>Netmask</th> <th></th> </tr> </thead> <tbody> <tr> <td>1</td> <td>lan0</td> <td>10.0.0.1</td> <td>255.255.255.0</td> <td>   </td> </tr> </tbody> </table>			Index	Interface	IP Address	Netmask		1	lan0	10.0.0.1	255.255.255.0	 
Index	Interface	IP Address	Netmask									
1	lan0	10.0.0.1	255.255.255.0	 								

You may click  to add a multiple IP to the LAN port, or click  to delete the multiple IP of the LAN port. Now, click  to edit the multiple IP of the LAN port.

Multiple IP	
IP Settings	
Index	<input type="text" value="1"/>
Interface	<input type="text" value="lan0"/>
IP Address	<input type="text" value="10.0.0.1"/>
Netmask	<input type="text" value="255.255.255.0"/>

IP Settings

Item	Description	Default
Index	Indicate the ordinal of the list.	--
Interface	Show the editing port, read only.	--
IP Address	Set the multiple IP address of the LAN port.	Null
Netmask	Set the multiple Netmask of the LAN port.	Null

Status

This section allows you to view the status of LAN connection.

LAN	Multiple IP	Status										
^ Interface Status <table border="1"> <thead> <tr> <th>Index</th> <th>Interface</th> <th>IP Address</th> <th>MAC Address</th> </tr> </thead> <tbody> <tr> <td>1</td> <td>lan0</td> <td>192.168.0.1/255.2...</td> <td>34:FA:40:0B:68:AC</td> </tr> </tbody> </table>			Index	Interface	IP Address	MAC Address	1	lan0	192.168.0.1/255.2...	34:FA:40:0B:68:AC		
Index	Interface	IP Address	MAC Address									
1	lan0	192.168.0.1/255.2...	34:FA:40:0B:68:AC									
^ Connected Devices <table border="1"> <thead> <tr> <th>Index</th> <th>IP Address</th> <th>MAC Address</th> <th>Interface</th> <th>Inactive Time</th> </tr> </thead> <tbody> <tr> <td>1</td> <td>192.168.0.5</td> <td>D4:3A:65:05:FC:4A</td> <td>lan0</td> <td>0s</td> </tr> </tbody> </table>			Index	IP Address	MAC Address	Interface	Inactive Time	1	192.168.0.5	D4:3A:65:05:FC:4A	lan0	0s
Index	IP Address	MAC Address	Interface	Inactive Time								
1	192.168.0.5	D4:3A:65:05:FC:4A	lan0	0s								
^ DHCP Lease Table <table border="1"> <thead> <tr> <th>Index</th> <th>IP Address</th> <th>MAC Address</th> <th>Interface</th> <th>Expired Time</th> </tr> </thead> <tbody> <tr> <td>1</td> <td>192.168.0.5</td> <td>d4:3a:65:05:fc:4a</td> <td>lan0</td> <td>0 days, 01:51:32</td> </tr> </tbody> </table>			Index	IP Address	MAC Address	Interface	Expired Time	1	192.168.0.5	d4:3a:65:05:fc:4a	lan0	0 days, 01:51:32
Index	IP Address	MAC Address	Interface	Expired Time								
1	192.168.0.5	d4:3a:65:05:fc:4a	lan0	0 days, 01:51:32								

Click the row of status, the details status information will be display under the row. Please refer to the screenshot below.

^ Interface Status																			
Index	Interface	IP Address	MAC Address																
1	lan0	192.168.0.1/255.2...	34:FA:40:0B:68:AC																
<table border="1"> <tbody> <tr> <td>Index</td> <td>1</td> </tr> <tr> <td>Interface</td> <td>lan0</td> </tr> <tr> <td>IP Address</td> <td>192.168.0.1/255.255.255.0</td> </tr> <tr> <td>MAC Address</td> <td>34:FA:40:0B:68:AC</td> </tr> <tr> <td>RX Packets</td> <td>14470</td> </tr> <tr> <td>TX Packets</td> <td>12759</td> </tr> <tr> <td>RX Bytes</td> <td>2849614</td> </tr> <tr> <td>TX Bytes</td> <td>10657230</td> </tr> </tbody> </table>				Index	1	Interface	lan0	IP Address	192.168.0.1/255.255.255.0	MAC Address	34:FA:40:0B:68:AC	RX Packets	14470	TX Packets	12759	RX Bytes	2849614	TX Bytes	10657230
Index	1																		
Interface	lan0																		
IP Address	192.168.0.1/255.255.255.0																		
MAC Address	34:FA:40:0B:68:AC																		
RX Packets	14470																		
TX Packets	12759																		
RX Bytes	2849614																		
TX Bytes	10657230																		

3.8 Interface > Ethernet

This section allows you to set the related parameters for Ethernet. There are four Ethernet ports on R2110 Router, including ETH0, ETH1, ETH2 and ETH3. The ETH0 on the router can be configured as a WAN port, while ETH1, ETH2 and ETH3 can only be configured as a LAN port. By default, ETH1, ETH2 and ETH3 are lan0, and their IP are 192.168.0.1/255.255.255.0. Since lan0 must be assigned to one port and WAN port must be assigned to the ETH0. This section introduces you to set the parameters of the WAN port.

Ports		Status
^ Port Settings ?		
Index	Port	Port Assignment
1	eth0	wan
2	eth1	lan0
3	eth2	lan0
4	eth3	lan0

Click button of eth0 to configure its parameters. The port assignment can't be changed by selecting from the drop down list.

Ports	
^ Port Settings	
Index	<input type="text" value="1"/>
Port	<input type="text" value="eth0"/>
Port Assignment	<input type="text" value="wan"/> ?

Port Settings		
Item	Description	Default
Index	Indicate the ordinal of the list.	--
Port	Show the editing port, read only.	--
Port Assignment	Choose the Ethernet port's type, as a WAN port.	wan

This section introduces you to set the parameters of the LAN port.

Ports		Status
^ Port Settings ?		
Index	Port	Port Assignment
1	eth0	wan
2	eth1	lan0
3	eth2	lan0
4	eth3	lan0

Click button of eth1 or eth2 or eth3 to configure its parameters. The port assignment can be changed by selecting from the drop down list.

Ports

^ **Port Settings**

Index

Port

Port Assignment ?

Port Settings		
Item	Description	Default
Index	Indicate the ordinal of the list.	--
Port	Show the editing port, read only.	--
Port Assignment	Choose the Ethernet port's type, as a WAN port or a LAN port. When setting the port as a LAN port in Interface > LAN > LAN > Network Settings > General Settings , you can click the drop-down list to select from "lan0", "lan1" or "lan2".	lan0

This column allows you to view the status of Ethernet port.

Ports		Status
^ Port Status		
Index	Port	Link
1	eth0	Down
2	eth1	Down
3	eth2	Down
4	eth3	Up

Click the row of status, the details status information will be display under the row. Please refer to the screenshot below.

Ports		Status
^ Port Status		
Index	Port	Link
1	eth0	Down
2	eth1	Down
3	eth2	Down
4	eth3	Up
<p>Index 4</p> <p>Port eth3</p> <p>Link Up</p>		

3.9 Interface > Cellular

This section allows you to set the related parameters of Cellular. The R2110 Router has two SIM card slots, but do not support two SIM cards online simultaneously due to its single-module design. If insert single SIM card at the first time, SIM1 slot and SIM2 slots are available.

Index	SIM Card	Phone Number	Network Type	Band Select Type	
1	SIM1		Auto	All	
2	SIM2		Auto	All	

Click of SIM 1 to edit the parameters.

Cellular

^ **General Settings**

Index:

SIM Card: v

Phone Number:

PIN Code: ?

Extra AT Cmd: ?

Telnet Port: ?

The window is displayed as below when choosing “Auto” as the network type.

^ **Cellular Network Settings**

Network Type: v ?

Band Select Type: v ?

^ **Advanced Settings**

Debug Enable: ON OFF

Verbose Debug Enable: ON OFF

The window is displayed as below when choosing “Specify” as the band select type.

^ Cellular Network Settings

Network Type v ?

Band Select Type v ?

^ Band Settings

LTE Band 1 OFF

LTE Band 19 OFF

LTE Band 21 OFF

^ Advanced Settings

Debug Enable ON OFF

Verbose Debug Enable ON OFF

Cellular		
Item	Description	Default
General Settings		
Index	Indicate the ordinal of the list.	--
SIM Card	Set the currently editing SIM card.	SIM1
Phone Number	Enter the phone number of the SIM card.	Null
PIN Code	Enter a 4-8 characters PIN code used for unlocking the SIM.	Null
Extra AT Cmd	Enter the AT commands used for cellular initialization.	Null
Telnet Port	Specify the Port listening of telnet service, used for AT over Telnet.	0
Cellular Network Settings		
Network Type	Select from "Auto", "4G Only", "4G First". <ul style="list-style-type: none"> Auto: Connect to the best signal network automatically 4G Only: Only the 4G network is connected 4G First: Connect to the 4G Network preferentially 	Auto
Band Select Type	Select from "All" or "Specify". You may choose certain bands if choosing "Specify".	All
Advanced Settings		
Debug Enable	Click the toggle button to enable/disable this option. Enable for debugging information output.	ON
Verbose Debug Enable	Click the toggle button to enable/disable this option. Enable for verbose debugging information output.	OFF

This section allows you to view the status of the cellular connection.

^ Status

Cellular	Status	AT Debug		
Index	Modem Status	Modem Model	IMSI	Registration
1	Ready	HL7549	460012148626825	Registered to home network

Click the row of status, the details status information will be displayed under the row.

^ Status				
Index	Modem Status	Modem Model	IMSI	Registration
1	Ready	HL7539	460012148626827	Registered to home network
Index 1				
Modem Status Ready				
Modem Model HL7539				
Current SIM SIM1				
Phone Number				
IMSI 460012148626827				
ICCID 89860117851023142414				
Registration Registered to home network				
Network Provider CHN-UNICOM				
Network Type LTE				
Band 1				
Signal Strength 2 (-109dBm)				
RSRP -108 dBm				
RSRQ -8.5 dBm				
Bit Error Rate 4				
PLMN ID 46001				
Local Area Code FFFF				
Cell ID 06CECE20				
IMEI 352632070897933				
Firmware Version RHL7539.2.8.173700.201709291522.x7160_1				

Status	
Item	Description
Index	Indicate the ordinal of the list.
Modem Status	Show the status of the radio module.
Modem Model	Show the model of the radio module.
Current SIM	Show the SIM card that your router is using.
Phone Number	Show the phone number of the current SIM. Note: This option will be displayed if enter manually in Cellular > Advanced Cellular Settings > SIM1/SIM2 > General Settings > Phone Number .
IMSI	Show the IMSI number of the current SIM.
ICCID	Show the ICCID number of the current SIM.
Registration	Show the current network status.
Network Provider	Show the name of Network Provider.
Network Type	Show the current network service type, e.g. GPRS.
Band	Show the band of the current network.

Status	
Item	Description
Signal Strength	Show the signal strength detected by the mobile.
RSRP	Show the Reference Signal Receiving Power (RSRP) of the current network.
RSRQ	Show the Reference Signal Receiving Quality (RSRQ) of the current network.
Bit Error Rate	Show the current bit error rate.
PLMN ID	Show the current PLMN ID.
Local Area Code	Show the current local area code used for identifying different area.
Cell ID	Show the current cell ID used for locating the router.
IMEI	Show the IMEI (International Mobile Equipment Identity) number of the radio module.
Firmware Version	Show the current firmware version of the radio module.

This page allows you to check the AT Debug.

Cellular
Status
AT Debug

^ At Debug

Command

Result

AT Debug		
Item	Description	Default
Command	Enter the AT command that you want to send to cellular module in this text box.	Null
Result	Show the AT command responded by cellular module in this text box.	Null
<input style="background-color: #2c5e8c; color: white; padding: 2px 10px;" type="button" value="Send"/>	Click the button to send AT command.	--

3.10 Interface > WiFi

This section allows you to configure the parameters of two WiFi modes. Router supports either WiFi AP mode or Client mode, and defaults as AP.

WiFi AP

Configure Router as WiFi AP

Click **Interface > WiFi > WiFi**, select “AP” as the mode and click “Submit”.

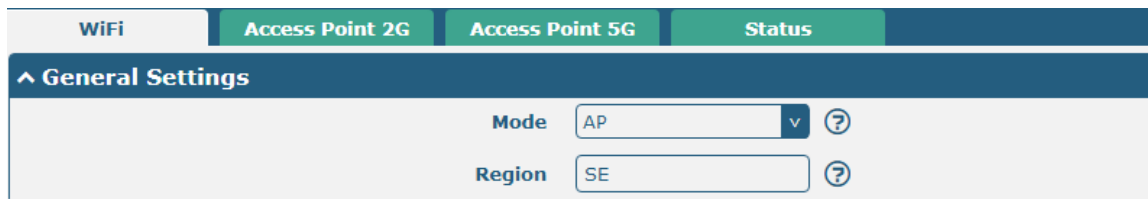

WiFi	Access Point 2G	Access Point 5G	Status
^ General Settings			
	Mode	AP	?
	Region	SE	?

Note: Please remember to click **Save & Apply** after finish the configuration, so that the configuration can be took effect.

Click the **Access Point 2G** column to configure the parameters of WiFi AP. By default, the security mode is set as “Disabled”.

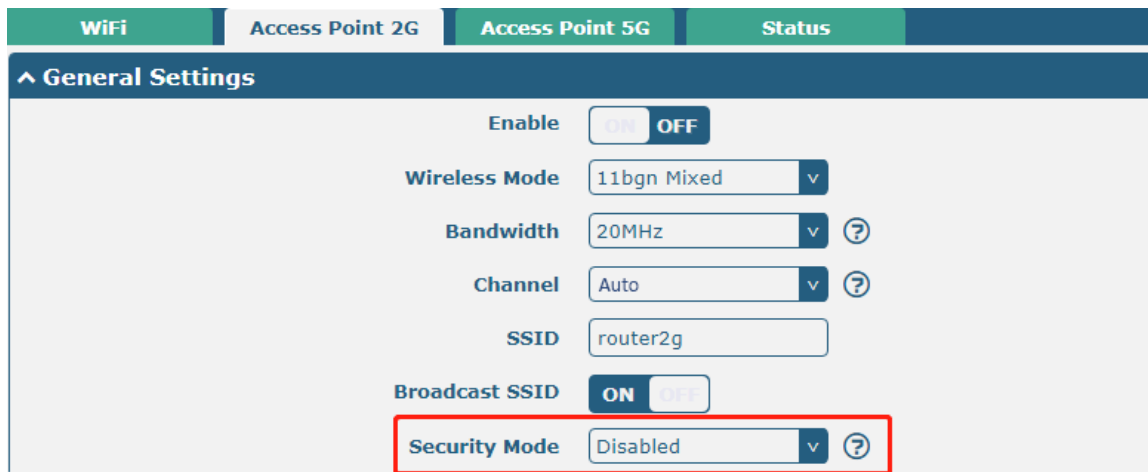

WiFi	Access Point 2G	Access Point 5G	Status
^ General Settings			
	Enable	ON	OFF
	Wireless Mode	11bgn Mixed	v
	Bandwidth	20MHz	v ?
	Channel	Auto	v ?
	SSID	router2g	
	Broadcast SSID	ON	OFF
	Security Mode	Disabled	v ?

The window is displayed as below when setting “WPA-Personal” as the security mode.

The screenshot shows the 'General Settings' interface for 'Access Point 2G'. The 'Enable' toggle is turned off. The 'Wireless Mode' is set to '11bgn Mixed', 'Bandwidth' to '20MHz', and 'Channel' to 'Auto'. The 'SSID' is 'router2g' and 'Broadcast SSID' is turned on. The 'Security Mode' dropdown is highlighted with a red box and set to 'WPA-Personal'. Other settings include 'WPA Version' (Auto), 'Encryption' (AES), 'PSK Password' (empty), and 'Group Key Update Interval' (3600).

The window is displayed as below when setting “WEP” as the security mode.

The screenshot shows the 'General Settings' interface for 'Access Point 2G' with 'WEP' selected as the security mode. The 'Security Mode' dropdown is highlighted with a red box. The 'WEP Key' field is visible at the bottom.

General Settings @ Access Point 2G		
Item	Description	Default
Enable	Click the toggle button to enable/disable the WiFi access point option.	OFF
Wireless Mode	Select from “11bgn Mixed”, “11b only”, “11g only” and “11n only”. <ul style="list-style-type: none"> 11bgn Mixed: mix three protocols for backward compatibility 11b only: IEEE 802.11b, 11 Mbps~2.4GHz 11g only: IEEE 802.11g, 54 Mbps~2.4GHz 11n only: IEEE 802.11n, 450 Mbps 	11bgn Mixed

General Settings @ Access Point 2G		
Item	Description	Default
Bandwidth	Select from "20 MHz" or "40MHz". Note: 40 MHz channel width provides twice the data rate available over a single 20 MHz channel;	20MHz
Channel	<p>The channel that different bandwidth can choose is as follows.</p> <ul style="list-style-type: none"> • Auto: Router will scan all frequency channels until the best one is found • 1~13 channel will be fixed to work with this channel <p>Following are the frequency of 1~13 channel:</p> <p>1-2412 MHz 2-2417 MHz 3-2422 MHz 4-2427 MHz 5-2432 MHz 6-2437 MHz 7-2442 MHz 8-2447 MHz 9-2452 MHz 10-2457 MHz 11-2462 MHz 12-2467 MHz 13-2472 MHz</p> <ul style="list-style-type: none"> • The frequency of 3~11 channels of 40MHz bandwidth available channel: <p>3-2422 MHz 4-2427 MHz 5-2432 MHz 6-2437 MHz 7-2442 MHz 8-2447 MHz 9-2452 MHz 10-2457 MHz 11-2462 MHz</p>	Auto
SSID	Enter the Service Set Identifier, the name of your wireless network. The SSID of a client and the SSID of the AP must be identical for the client and AP to be able to communicate with each other. Enter 1 to 32 characters.	router

General Settings @ Access Point 2G		
Item	Description	Default
Broadcast SSID	Click the toggle button to enable/disable the SSID being broadcast. When enabled, the client can scan your SSID. When disabled, the client cannot scan your SSID. If you want to connect to the router AP, you need to manually enter the SSID of router AP at WiFi client side.	ON
Security Mode	Select from "Disabled", "WPA-Personal" or "WEP". <ul style="list-style-type: none"> Disabled: User can access the WiFi without password Note: It is strongly recommended for security purposes that you do not choose this kind of mode. WPA-personal: WiFi access protection, only one password is provided for identity authentication WEP: Wired Equivalent Privacy provides encryption for wireless device's data transmission 	Disabled
WPA Version	Select from "Auto", "WPA" or "WPA2". <ul style="list-style-type: none"> Auto: Router will choose automatically the most suitable WPA version WPA2 is a stronger security feature than WPA 	Auto
Encryption	Select from "TKIP" or "AES". <ul style="list-style-type: none"> TKIP: Temporal Key Integrity Protocol (TKIP) encryption uses a wireless connection. TKIP encryption can be used for WPA-PSK and WPA 802.1x authentication AES: AES encryption uses a wireless connection. AES can be used for CCMP WPA-PSK and WPA 802.1x authentication. AES is a stronger encryption algorithm than TKIP Note: The security mode will affect wireless communication rate. Different wireless modes support different encryption modes. For example, 802.11n supports neither WEP security mode nor TKIP algorithm. If they are used, the wireless communication rate will reduce to 54Mbps (802.11g mode). It is recommended to select AES in 802.11n mode.	AES

General Settings @ Access Point 2G		
Item	Description	Default
PSK Password	Enter the Pre share key password. When router works as AP mode, enter Master key to generate keys for encryption. A PSK Password is used as a basis for encryption methods (or cipher types) in a WLAN connection. The PSK Password should be complicated and as long as possible. For security reasons, this PSK Password should only be disclosed to users who need it, and it should be changed regularly. Enter 8 to 63 characters.	Null
Group Key Update Interval	Enter the time period of group key renewal.	3600
WEP Key	Enter the WEP key. The key length should be 10 or 26 hexadecimal digits depending on which WEP key is used, 64 digits or 128 digits.	Null

^ Advanced Settings

Max Associated Stations	<input type="text" value="0"/>	?
Beacon Interval	<input type="text" value="100"/>	?
DTIM Period	<input type="text" value="2"/>	?
RTS Threshold	<input type="text" value="2347"/>	?
Fragmentation Threshold	<input type="text" value="2346"/>	?
Transmit Rate	<input type="text" value="Auto"/>	v
11N Transmit Rate	<input type="text" value="Auto"/>	v
Transmit Power	<input type="text" value="Max"/>	v
Enable WMM	<input checked="" type="checkbox"/> ON <input type="checkbox"/> OFF	
Enable Short GI	<input checked="" type="checkbox"/> ON <input type="checkbox"/> OFF	?
Enable AP Isolation	<input type="checkbox"/> ON <input checked="" type="checkbox"/> OFF	?
Debug Level	<input type="text" value="none"/>	v

Advanced Settings @ Access Point 2G		
Item	Description	Default
Max Associated Stations	Set the max number of clients allowed to access the router’s AP. (Value 0 means without limitation)	0
Beacon Interval	Set the interval of time in which the router AP broadcasts a beacon which is used for wireless network authentication.	100
DTIM Period	Set the delivery traffic indication message period and the router AP will multicast the data according to this period.	2
RTS Threshold	Set the “request to send” threshold. When the threshold set as 2347, the router AP will not send detection signal before sending data. And when the threshold set as 0, the router AP will send	2347

Advanced Settings @ Access Point 2G		
Item	Description	Default
	detection signal before sending data.	
Fragmentation Threshold	Set the fragmentation threshold of a WiFi AP. It is recommended that you use the default value 2346.	2346
Transmit Rate	Set the transmit rate. You can choose Auto or specify a Transmit Rate, including 1Mbps, 2Mbps, 5.5Mbps, 6Mbps, 11Mbps, 12Mbps, 18Mbps, 24Mbps, 36Mbps, 48Mbps and 54Mbps.	Auto
11N Transmit Rate	Specify the transmit rate under the IEEE 802.11n mode or let it be default to "Auto". Select from MCS0, MCS1, MCS2, MCS3, MCS4, MCS5, MCS6, MCS7, MCS8, MCS9, MCS10, MCS11, MCS12, MCS13, MCS14 and MCS15.	Auto
Transmit Power	Select from "Max", "High", "Medium" or "Low".	Max
Enable WMM	Click the toggle button to enable/disable the WMM option.	ON
Enable Short GI	Click the toggle button to enable/disable the Short Guard Interval option. Short GI is a blank time between two symbols, providing a long buffer time for signal delay. Using the Short GI would increase 11% in data rates, but also result in higher packet error rates.	ON
Enable AP Isolation	Click the toggle button to enable/disable the AP isolation option. When enabled, the router will isolate all connected wireless devices. The wireless device cannot access the router directly via WLAN.	OFF
Debug Level	Select from "verbose", "debug", "info", "notice", "warning" or "none".	none

^ ACL Settings

Enable ACL

 ON OFF

ACL Mode

Accept



^ Access Control List

Index

Description

MAC Address



Click **+** to add a MAC address to the Access Control List. The maximum count for MAC address is 64.

Access Point 2G

^ **Access Control List**

Index	<input style="width: 100%;" type="text" value="1"/>
Description	<input style="width: 100%;" type="text"/>
MAC Address	<input style="width: 100%;" type="text"/>

ACL Settings @ Access Point 2G		
Item	Description	Default
Enable ACL	Click the toggle button to enable/disable this option.	OFF
ACL Mode	Select from "Accept" or "Deny". <ul style="list-style-type: none"> Accept: Only the packets fitting the entities of the "Access Control List" can be allowed Deny: All the packets fitting the entities of the "Access Control List" will be denied Note: Router can only allow or deny devices which are included in "Access Control List" at one time.	Accept
Access Control List @ Access Point 2G		
Index	Indicate the ordinal of the list.	--
Description	Enter a description for this access control list.	Null
MAC Address	Add a MAC address here.	Null

Click the **Access Point 5G** column to configure the parameters of WiFi AP. By default, the security mode is set as “Disabled”.

The screenshot shows the 'Access Point 5G' configuration page. At the top, there are four tabs: 'WiFi', 'Access Point 2G', 'Access Point 5G', and 'Status'. Below the tabs is a section titled 'General Settings'. The settings include:

- Enable: ON OFF
- Wireless Mode: 11an
- Bandwidth: 20MHz
- Channel: 36
- SSID: router5g
- Broadcast SSID: ON OFF
- Security Mode: Disabled (highlighted with a red box)

The window is displayed as below when setting “WPA-Personal” as the security mode.

The screenshot shows the 'Access Point 5G' configuration page with the 'Security Mode' dropdown highlighted in red and set to 'WPA-Personal'. The settings include:

- Enable: ON OFF
- Wireless Mode: 11an
- Bandwidth: 20MHz
- Channel: 36
- SSID: router5g
- Broadcast SSID: ON OFF
- Security Mode: WPA-Personal (highlighted with a red box)
- WPA Version: Auto
- Encryption: AES
- PSK Password: (empty field)
- Group Key Update Interval: 3600

The window is displayed as below when setting “WEP” as the security mode.

The screenshot shows the 'General Settings' interface for 'Access Point 5G'. The 'Security Mode' dropdown menu is highlighted with a red box and is currently set to 'WEP'. Other settings include: Enable (OFF), Wireless Mode (11an), Bandwidth (20MHz), Channel (36), SSID (router5g), Broadcast SSID (ON), and WEP Key (empty).

General Settings @ Access Point 5G		
Item	Description	Default
Enable	Click the toggle button to enable/disable the WiFi access point option.	OFF
Wireless Mode	Select from “11an”, or “11/a/an/ac”. <ul style="list-style-type: none"> 11an : Compatible IEEE 802.11a, 54 Mbps and IEEE 802.11n, 300Mbps 11n/a/an/ac: Compatible IEEE 802.11a, 54 Mbps、IEEE802.11n 300 Mbps and 802.11ac, 867 Mbps 	11an
Bandwidth	Select from “20MHz”, “40MHz” or “80MHz”. Note: 40 MHz channel width provides twice the data rate available over a single 20 MHz channel; the data transfer rate of 80MHz bandwidth is 4 times greater than that of a single 20Mhz bandwidth.	20MHz
Channel	The optional channels for bandwidths are as below. <ul style="list-style-type: none"> The frequency of 8~165 channels of 20MHz bandwidth available channels: <ul style="list-style-type: none"> 8–5040 MHz 12–5060 MHz 16–5080 MHz 36–5180 MHz 40–5200 MHz 44–5220 MHz 48–5240 MHz 52–5260 MHz 56–5280 MHz 60–5300 MHz 64–5320 MHz 100–5500 MHz 104–5520 MHz 	36

General Settings @ Access Point 5G		
Item	Description	Default
	108–5540 MHz 112–5560 MHz 116–5580 MHz 120–5600 MHz 124–5620 MHz 128–5640 MHz 132–5660 MHz 136–5680 MHz 140–5700 MHz 149–5745 MHz 153–5765 MHz 157–5785 MHz 161–5805 MHz 165–5825 MHz	
	<ul style="list-style-type: none"> The frequency of 38~159 channels of 40MHz bandwidth available channels: 38–5190 MHz 42–5210 MHz 46–5230 MHz 54–5270 MHz 62–5310 MHz 102–5510 MHz 110–5550 MHz 118–5590 MHz 126–5630 MHz 134–5670 MHz 142–5710 MHz 151–5755 MHz 159–5795 MHz The frequency of 42~155 channels of 80MHz bandwidth available channels: 42–5210 MHz 58–5290 MHz 106–5530 MHz 122–5610 MHz 138–5690 MHz 155–5775 MHz 	
	<p>Note: All available channels of 5GHz WiFi in different bandwidths are listed above. Web parameters should be configured due to the different available channels in different countries and areas.</p>	

General Settings @ Access Point 5G		
Item	Description	Default
SSID	Enter the Service Set Identifier, the name of your wireless network. The SSID of a client and the SSID of the AP must be identical for the client and AP to be able to communicate with each other. Enter 1 to 32 characters.	router
Broadcast SSID	Click the toggle button to enable/disable the SSID being broadcast. When enabled, the client can scan your SSID. When disabled, the client cannot scan your SSID. If you want to connect to the router AP, you need to manually enter the SSID of router AP at WiFi client side.	ON
Security Mode	Select from "Disabled", "WPA-Personal", or "WEP". <ul style="list-style-type: none"> Disabled: User can access the WiFi without password Note: It is strongly recommended for security purposes that you do not choose this kind of mode. WPA-personal: WiFi access protection, only one password is provided for identity authentication WEP: Wired Equivalent Privacy provides encryption for wireless device's data transmission 	Disabled
WPA Version	Select from "Auto", "WPA" or "WPA2". <ul style="list-style-type: none"> Auto: Router will choose automatically the most suitable WPA version WPA2 is a stronger security feature than WPA 	Auto
Encryption	Select from "TKIP" or "AES". <ul style="list-style-type: none"> TKIP: Temporal Key Integrity Protocol (TKIP) encryption uses a wireless connection. TKIP encryption can be used for WPA-PSK and WPA 802.1x authentication AES: AES encryption uses a wireless connection. AES can be used for CCMP WPA-PSK and WPA 802.1x authentication. AES is a stronger encryption algorithm than TKIP Note: The security mode will affect wireless communication rate. Different wireless modes support different encryption modes. For example, 802.11n supports neither WEP security mode nor TKIP algorithm. If they are used, the wireless communication rate will reduce to 54Mbps (802.11g mode). It is recommended to select AES in 802.11n mode.	TKIP

General Settings @ Access Point 5G		
Item	Description	Default
PSK Password	Enter the Pre share key password. When router works as AP mode, enter Master key to generate keys for encryption. A PSK Password is used as a basis for encryption methods (or cipher types) in a WLAN connection. The PSK Password should be complicated and as long as possible. For security reasons, this PSK Password should only be disclosed to users who need it, and it should be changed regularly. Enter 8 to 63 characters.	Null
Group Key Update Interval	Enter the time period of group key renewal.	3600
WEP Key	Enter the WEP key. The key length should be 10 or 26 hexadecimal digits depending on which WEP key is used, 64 digits or 128 digits.	Null

^ Advanced Settings

Max Associated Stations	<input type="text" value="0"/>	?
Beacon Interval	<input type="text" value="100"/>	?
DTIM Period	<input type="text" value="2"/>	?
RTS Threshold	<input type="text" value="2347"/>	?
Fragmentation Threshold	<input type="text" value="2346"/>	?
Transmit Rate	<input type="text" value="Auto"/>	v
11N Transmit Rate	<input type="text" value="Auto"/>	v
Transmit Power	<input type="text" value="Max"/>	v
Enable WMM	<input checked="" type="checkbox"/> ON <input type="checkbox"/> OFF	
Enable Short GI	<input checked="" type="checkbox"/> ON <input type="checkbox"/> OFF	?
Enable AP Isolation	<input type="checkbox"/> ON <input checked="" type="checkbox"/> OFF	?
Debug Level	<input type="text" value="none"/>	v

Advanced Settings @ Access Point 5G		
Item	Description	Default
Max Associated Stations	Set the max number of clients allowed to access the router’s AP. (Value 0 means without limitation)	0
Beacon Interval	Set the interval of time in which the router AP broadcasts a beacon which is used for wireless network authentication.	100
DTIM Period	Set the delivery traffic indication message period and the router AP will multicast the data according to this period.	2
RTS Threshold	Set the “request to send” threshold. When the threshold set as 2347, the router AP will not send detection signal before sending data. And when the threshold set as 0, the router AP will send	2347

Advanced Settings @ Access Point 5G		
Item	Description	Default
	detection signal before sending data.	
Fragmentation Threshold	Set the fragmentation threshold of a WiFi AP. It is recommended that you use the default value 2346.	2346
Transmit Power	Select from “Max”, “High”, “Medium” or “Low”.	Max
Enable WMM	Click the toggle button to enable/disable the WMM option.	ON
Enable Short GI	Click the toggle button to enable/disable the Short Guard Interval option. Short GI is a blank time between two symbols, providing a long buffer time for signal delay. Using the Short GI would increase 11% in data rates, but also result in higher packet error rates.	ON
Enable AP Isolation	Click the toggle button to enable/disable the AP isolation option. When enabled, the router will isolate all connected wireless devices. The wireless device cannot access the router directly via WLAN.	OFF
Debug Level	Select from “verbose”, “debug”, “info”, “notice”, “warning” or “none”.	none

Click **+** to add a MAC address to the Access Control List. The maximum count for MAC address is 64.

Access Point 5G

^ Access Control List

Index	<input type="text" value="1"/>	
Description	<input type="text"/>	
MAC Address	<input type="text"/>	

ACL Settings @ Access Point 5G		
Item	Description	Default
Enable ACL	Click the toggle button to enable/disable this option.	OFF
ACL Mode	Select from “Accept” or “Deny”. <ul style="list-style-type: none"> Accept: Only the packets fitting the entities of the “Access Control List” can be allowed Deny: All the packets fitting the entities of the “Access Control List” will be denied Note: Router can only allow or deny devices which are included in “Access Control List” at one time.	Accept
Access Control List @ Access Point 5G		
Index	Indicate the ordinal of the list.	--
Description	Enter a description for this access control list.	Null
MAC Address	Add a MAC address here.	Null

This section allows you to view the status of AP.

WiFi | Access Point 2G | Access Point 5G | Status

^ AP Status 2G

Status COMPLETED

Channel

Channel Width

MAC Address BA:81:12:0C:04:8B

^ Associated Stations 2G

Index	MAC Address	IP Address	Name	Connected Time	Signal
-------	-------------	------------	------	----------------	--------

^ AP Status 5G

Status

Channel

Channel Width

MAC Address

^ Associated Stations 5G

Index	MAC Address	IP Address	Name	Connected Time	Signal
-------	-------------	------------	------	----------------	--------

Note: WiFi is off by default. Follow the steps below to enable it and configure the router as WiFi client.

WiFi Client

Configure Router as WiFi Client

Click **Interface > WiFi > WiFi**, select “Client” as the mode and regarding the AP type to choose the related Client Band then click “Submit”.

WiFi

^ General Settings

Mode Client v ?

Client Band 2.4G v ?

Region SE ?

And then a “WLAN” column will appear under the Interface list.

Status | WiFi

^ General Settings

Mode Client v ?

Region SE ?

Interface

- Link Manager
- LAN
- Ethernet
- Cellular
- WiFi
- WLAN

Click **Interface > Link Manager > Link Settings**, and click the edit button of WLAN, then configure its related parameters.

^ WLAN Settings

SSID

Connect to Hidden SSID ON OFF

Password

Click **Interface > WLAN** to configure the parameters of WiFi Client after setting the mode as Client. Please remember to click **Save & Apply > Reboot** after finish the configuration, so that the configuration can be took effect.

Status

^ WLAN Status

Status Connected

Uptime 0 days, 00:00:17

IP Address 192.168.1.128/255.255.255.0

Gateway 192.168.1.253

DNS 172.16.0.1 202.96.209.6

MAC Address 00:23:a7:a4:13:e4

^ Link Status

Signal -70 dBm

Noise -95 dBm

Width 40 MHz

TX Bitrate 1.0 MBit/s

TX 2195 bytes (14 packets)

RX 23484 bytes (213 packets)

^ WPA Status

WPA State COMPLETED

Frequency 2.437 GHz

BSSID 3c:46:d8:23:5d:5a

SSID Michael's

Mode station

Key Management WPA2-PSK

Pairwise Cipher CCMP

Group Cipher CCMP

^ Scan Results ⋮

Index	SSID	MAC Address	Frequency	Signal
1	Michael's	3C:46:D8:23:5D:5A	2437	60 dBm

This window allows you to scan for all available SSIDs in your area and connect to one of those shown on the “Scan Results” list.

Index	SSID	MAC Address	Frequency	Signal
1	Michael's	3C:46:D8:23:5D:5A	2437	58 dBm
2	Robustel-Client	34:FA:40:06:7F:8B	2412	58 dBm
3	cfg_ap_ssid	00:23:A7:A3:F2:B8	2462	59 dBm
4	Cao's	34:FA:40:09:E4:49	2437	67 dBm
5	Anjiu	88:25:93:D4:CE:A2	2437	71 dBm
6	FT-VIP	3C:8C:40:D4:47:90	2452	73 dBm
7	FT	3C:8C:40:D4:47:91	2452	73 dBm

3.11 Interface > USB

This section allows you to set the USB parameters. The USB interface of the router can be used for firmware upgrade and configuration upgrade.

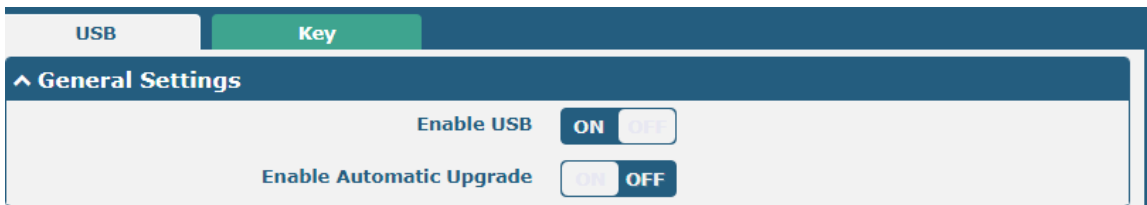

General Settings @ USB		
Item	Description	Default
Enable USB	Click the toggle button to enable/disable the USB option.	ON
Enable Automatic Upgrade	Click the toggle button to enable/disable this option. Enable to automatically update the firmware of the router when inserting a USB storage device with a router firmware.	OFF

Router has the key for USB automatic update. User can generate the key in this page.

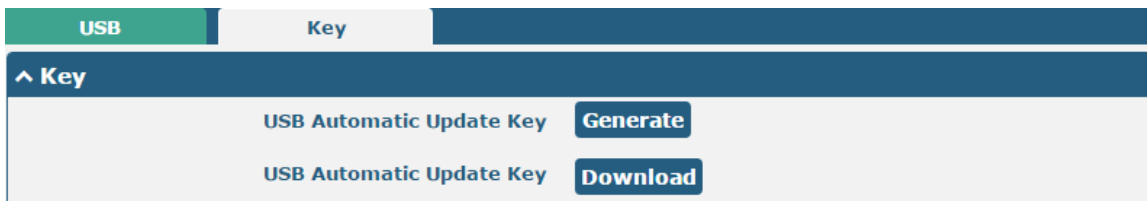

Key		
Item	Description	Default
USB Automatic Update Key	Click Generate to generate a key, and click Download to download the key.	--

3.12 Interface > DI/DO

This section allows you to set the DI/DO parameters. Digital Input and Digital Output are the specific interfaces for R2100. The DI interface can be used for triggering alarm, while the DO can be used for controlling the slave device so as to realize real-time monitoring.

DI

DI	DO	Status	
^ DI Settings			
Index	Enable	Mode	Inversion
1	false	ON-OFF	false

Click the right-most button of index 1 as below. The default mode is “ON-OFF”.

DI

^ General Settings

Index

Enable ON OFF

Mode v

Inversion ON OFF

Alarm On Content

Alarm Off Content

The window is displayed as below when choosing “Counter” as the mode.

DI

^ General Settings

Index

Enable ON OFF

Mode v

Inversion ON OFF

Threshold Value

Alarm On Content

Alarm Off Content

General Settings @ DI		
Item	Description	Default
Index	Indicate the ordinal of the list.	--
Enable	Click the toggle button to enable/disable this DI.	OFF
Mode	Select from “ON-OFF” or “Counter”. <ul style="list-style-type: none"> ON-OFF: DI interface support ON and OFF mode (high or low level) 	ON-OFF

General Settings @ DI		
Item	Description	Default
	<p>electrical) trigger DI alarm. The mode default to ON, and OFF mode is available only when enabling the inversion feature</p> <p>ON—Under this mode, DI alarm status will be triggered to ON when DI interface open from GND or input a high level electrical (logic 1), on the contrary DI alarm status will be triggered to OFF when DI interface connect to GND or input a low level electrical (logic 0)</p> <p>OFF—Under this mode, DI alarm status will be triggered to ON when DI interface connect to GND or input a low level electrical (logic 0), on the contrary DI alarm status will be triggered to OFF when DI interface open from GND or input a high level electrical (logic 1)</p> <ul style="list-style-type: none"> Counter: Event counter mode 	
Inversion	Click the toggle button to enable/disable this option. Enable to set DI mode as OFF mode.	OFF
Threshold Value	Set the threshold vale. It will trigger alarm when event counter reaches this figure. After triggering alarm, DI will keep counting but not trigger alarm again. Enter 0 to 65535 digits. (0=will not trigger alarm) Note: This option is only available when DI under the “Counter” mode.	Null
Alarm On Content	Show the content when alarm on.	Alarm On
Alarm Off Content	Show the content when alarm off.	Alarm Off

Note: It defaults as high alarm, while turns to low alarm after enabling the “Inversion” button.

DO

DI	DO	Status			
^ DO Settings					
Index	Enable	Alarm On Action	Alarm Off Action	Initial State	Alarm Source
1	false	High	Low	Last	DI1 Alarm

Click to enter the DO configuration window.

DO

^ General Settings

Index:

Enable: ON OFF

Alarm On Action: v

Alarm Off Action: v

Initial State: v

Delay: ?

Hold Time: ?

Alarm Source: v

The window is displayed as below when choosing “Pulse” as the alarm on action.

^ General Settings

Index

Enable ON OFF

Alarm On Action

Alarm Off Action

Initial State

Delay ?

Hold Time ?

Low-level Width ?

High-level Width ?

Alarm Source

The window is displayed as below when choosing “Pulse” as the alarm off action.

^ General Settings

Index

Enable ON OFF

Alarm On Action

Alarm Off Action

Initial State

Delay ?

Hold Time ?

Low-level Width ?

High-level Width ?

Alarm Source

General Settings @ DO		
Item	Description	Default
Index	Indicate the ordinal of the list.	--
Enable	Click the toggle button to enable/disable this DO.	OFF
Alarm On Action	Digital Output initiates when there is an alarm. Selected from “High”, “Low” or “Pulse”. <ul style="list-style-type: none"> High: a high electrical level output Low: a low electrical level output Pulse: Generates a square wave as specified in the pulse mode parameters when triggered 	High

General Settings @ DO		
Item	Description	Default
Alarm Off Action	Digital Output initiates when alarm removed. Selected from “High”, “Low” or “Pulse”. <ul style="list-style-type: none"> High: a high electrical level output Low: a low electrical level output Pulse: Generates a square wave as specified in the pulse mode parameters when triggered 	Low
Initial State	Specify the Digital Output status when powered on. Selected from “Last”, “High” or “Low”. <ul style="list-style-type: none"> Last: DO’s status will consist with the status of last power off High: DO interface is in high electrical level Low: DO interface is in low electrical level 	Low
Delay	Set the delay time for DO alarm start-up. The first pulse will be generated after a “Delay”. Enter from 0 to 300000ms. (0=generate pulse without delay)	0
Hold Time	Set the hold time of DO status (Alarm On Action/Alarm Off Action). When the action time reach this specified time, DO will stop the action. Enter from 0 to 3000 seconds. (0=keep on until the next action)	0
Low-level Width	Set the low-level width. It is available when enabling Pulse as “Alarm On Action/Alarm Off Action”. In Pulse Output mode, the selected digital output channel will generate a square wave as specified in the pulse mode parameters. The low level widths are specified here. Enter from 1 to 3000 ms.	10
High-level Width	Set the high-level width. It is available when enabling Pulse as “Alarm On Action/Alarm Off Action”. In Pulse Output mode, the selected digital output channel will generate a square wave as specified in the pulse mode parameters. The high level widths are specified here. Enter from 1 to 3000 ms.	10
Alarm Source	Digital Output initiates according to different alarm source. Selected only “DI1 Alarm”. DI1 Alarm: Digital Output triggers the related action when there is alarm from Digital Input.	DI1 Alarm

Status

This window allows you to view the status of DO and DI interface. It also can clear the counter alarm of DI in here. Click **Clear** button to clear DI1 monthly usage statistics info for counter alarm.

DI
DO
Status

^ DI Status

Index	Level	Status	Count
1	High	Alarm off	

^ Action Of Clear

Counter Alarm Of DI 1
Clear

^ DO Status

Index	Level	Low-level Width	High-level Width
1	Low		

3.13 Interface > Serial Port

This section allows you to set the serial port parameters. R2110 Router supports one COM1 and one COM2, also can be configured as either two COM1 or two COM2. Serial port provides a way to transfer serial data to IP data, or vice versa, and transmit these data via wired or wireless network to achieve data transparent transmission.

Serial Port		Status			
^ Serial Port Settings					
Index	Port	Enable	Baud Rate	Application Mode	
1	COM1	false	115200	Transparent	
2	COM2	false	115200	Transparent	

Click the edit button of COM1.

Serial Port

^ Serial Port Application Settings

Index:

Port:

Enable: ON OFF

Baud Rate:

Data Bits:

Stop Bits:

Parity:

Flow Control:

^ Data Packing

Packing Timeout: 

Packing Length:

The window is displayed as below when choosing “Transparent” as the application mode and “TCP Client” as the protocol.

^ Server Setting

Application Mode:

Protocol:

Server Address:

Server Port:

The window is displayed as below when choosing “Transparent” as the application mode and “TCP Server” as the protocol.

^ Server Setting

Application Mode	<input type="text" value="Transparent"/>
Protocol	<input type="text" value="TCP Server"/>
Local IP	<input type="text"/>
Local Port	<input type="text"/>

The window is displayed as below when choosing “Transparent” as the application mode and “UDP” as the protocol.

^ Server Setting

Application Mode	<input type="text" value="Transparent"/>
Protocol	<input type="text" value="UDP"/>
Local IP	<input type="text"/>
Local Port	<input type="text"/>
Server Address	<input type="text"/>
Server Port	<input type="text"/>

The window is displayed as below when choosing “Transparent” as the application mode and “Robustlink” as the protocol.

^ Server Setting

Application Mode	<input type="text" value="Transparent"/>
Protocol	<input type="text" value="Robustlink"/>

The window is displayed as below when choosing “Modbus RTU Router” as the application mode and “TCP Client” as the protocol.

^ Server Setting

Application Mode	<input type="text" value="Modbus RTU Gatewa"/>
Protocol	<input type="text" value="TCP Client"/>
Server Address	<input type="text"/>
Server Port	<input type="text"/>

The window is displayed as below when choosing “Modbus RTU Router” as the application mode and “TCP Server” as the protocol.

^ Server Setting

Application Mode	<input type="text" value="Modbus RTU Gatewa"/>
Protocol	<input type="text" value="TCP Server"/>
Local IP	<input type="text"/>
Local Port	<input type="text"/>

The window is displayed as below when choosing “Modbus RTU Router” as the application mode and “UDP” as the

protocol.

^ Server Setting

Application Mode	Modbus RTU Gateway v
Protocol	UDP v
Local IP	<input type="text"/>
Local Port	<input type="text"/>
Server Address	<input type="text"/>
Server Port	<input type="text"/>

The window is displayed as below when choosing “Modbus RTU Router” as the application mode and “Robustlink” as the protocol.

^ Server Setting

Application Mode	Modbus RTU Gateway v
Protocol	Robustlink v

The window is displayed as below when choosing “Modbus ASCII Router” as the application mode and “TCP Client” as the protocol.

^ Server Setting

Application Mode	Modbus ASCII Gateway v
Protocol	TCP Client v
Server Address	<input type="text"/>
Server Port	<input type="text"/>

The window is displayed as below when choosing “Modbus ASCII Router” as the application mode and “TCP Server” as the protocol.

^ Server Setting

Application Mode	Modbus ASCII Gateway v
Protocol	TCP Server v
Local IP	<input type="text"/>
Local Port	<input type="text"/>

The window is displayed as below when choosing “Modbus ASCII Router” as the application mode and “UDP” as the protocol.

^ Server Setting

Application Mode

Protocol

Local IP

Local Port

Server Address

Server Port

The window is displayed as below when choosing “Modbus ASCII Router” as the application mode and “Robustlink” as the protocol.

^ Server Setting

Application Mode

Protocol

Serial Port		
Item	Description	Default
Serial Port Application Settings		
Index	Indicate the ordinal of the list.	--
Port	Show the current serial’s name, read only.	--
Enable	Click the toggle button to enable/disable this serial port. When the status is OFF, the serial port is not available.	OFF
Baud Rate	Select from “300”, “600”, “1200”, “2400”, “4800”, “9600”, “19200”, “38400”, “57600”, “115200” or “230400”.	115200
Data Bits	Select from “7” or “8”.	8
Stop Bits	Select from “1” or “2”.	1
Parity	Select from “None”, “Odd” or “Even”.	None
Flow control	Select from “None”, “Software” or “Hardware”.	None
Data Packing		
Packing Timeout	Set the packing timeout. The serial port will queue the data in the buffer and send the data to the Cellular WAN/Ethernet WAN when it reaches the Interval Timeout in the field. Note: Data will also be sent as specified by the packet length even when data is not reaching the interval timeout in the field.	50
Packing Length	Set the packet length. The Packet length setting refers to the maximum amount of data that is allowed to accumulate in the serial port buffer before sending. When a packet length between 1 and 3000 bytes is specified, data in the buffer will be sent as soon it reaches the specified length.	1200

Server Settings		
Item	Description	Default
Application Mode	Select from “Transparent”, “Modbus RTU Router” or “Modbus	Transparent

Server Settings		
Item	Description	Default
	ASCII Router". <ul style="list-style-type: none"> Transparent: Router will transmit the serial data transparently Modbus RTU Router: Router will translate the Modbus RTU data to Modbus TCP data and sent out, and vice versa Modbus ASCII Router: Router will translate the Modbus ASCII data to Modbus TCP data and sent out, and vice versa 	
Protocol	Select from "TCP Client", "TCP Server", "UDP" or "Robustlink". <ul style="list-style-type: none"> TCP Client: Router works as TCP client, initiate TCP connection to TCP server. Server address supports both IP and domain name TCP Server: Router works as TCP server, listening for connection request from TCP client UDP: Router works as UDP client Robustlink: Router will automatically upload the serial data to Robustlink platform under the Robustlink protocol. Robustlink is a management platform from Robustel. This function only available when Router is connects to Robustlink 	TCP Client
Server Address	Enter the address of server which will receive the data sent from router's serial port. IP address or domain name will be available.	Null
Server Port	Enter the specified port of server which is used for receiving the serial data.	Null
Local IP @ Transparent	Enter router's LAN IP which will forward to the internet port of router.	Null
Local Port @ Transparent	Enter the port of router's LAN IP.	Null
Local IP @ Modbus	Enter the local IP of under Modbus mode.	Null
Local Port @ Modbus	Enter the local port of under Modbus mode.	Null

Click the "Status" column to view the current serial port type.

Serial Port	Status			
^ Serial Port Status list				
Index	Type	TX	RX	Connection Status
1	RS232	0B	0B	
2	RS485	0B	0B	

3.14 Network > Route

This section allows you to set the static route. Static route is a form of routing that occurs when a router uses a

manually-configured routing entry, rather than information from a dynamic routing traffic. Route Information Protocol (RIP) is widely used in small network with stable use rate. Open Shortest Path First (OSPF) is made router within a single autonomous system and used in large network.

Static Route

Static Route
Status

^ Static Route Table

Index	Description	Destination	Netmask	Gateway	Interface	+
-------	-------------	-------------	---------	---------	-----------	---

Click **+** to add static route. The maximum count is 20.

Static Route

^ Static Route

Index

Description

Destination

Netmask

Gateway

Interface

Static Route		
Item	Description	Default
Index	Indicate the ordinal of the list.	--
Description	Enter a description for this route.	Null
Destination	Enter the IP address of destination host or destination network.	Null
Netmask	Enter the Netmask of destination host or destination network.	Null
Router	Define the router of the destination.	Null
Interface	Choose the corresponding port of the link that you want to configure.	wwan

Status

This window allows you to view the status of route.

Static Route
Status

^ Route Table

Index	Destination	Netmask	Gateway	Interface	Metric
1	0.0.0.0	0.0.0.0	10.122.74.9	wwan	0
2	10.122.74.8	255.255.255.248	0.0.0.0	wwan	0
3	172.16.0.0	255.255.0.0	0.0.0.0	lan0	0

3.15 Network > Firewall

This section allows you to set the firewall and its related parameters, including Filtering, Port Mapping, Custom Rules, DMZ and Status.

Filtering

The filtering rules can be used to either accept or block certain users or ports from accessing your router.

Filtering
Port Mapping
Custom Rules
DMZ
Status

^ General Settings

Enable Filtering ON OFF

Default Filtering Policy v ?

^ Access Control Settings

Enable Remote SSH Access ON OFF

Enable Local SSH Access ON OFF

Enable Remote Telnet Access ON OFF

Enable Local Telnet Access ON OFF

Enable Remote HTTP Access ON OFF

Enable Local HTTP Access ON OFF

Enable Remote HTTPS Access ON OFF

Enable Remote Ping Respond ON OFF ?

Enable DOS Defending ON OFF

Enable Remote IP Forwarding ON OFF

Enable Console ON OFF ?

^ Whitelist Rules ?

Index	Description	Source Address	+
			+

^ Filtering Rules

Index	Source Address	Source Port	Source MAC	Target Address	Target Port	Protocol	+
							+

Click **+** to add whitelist rules. The maximum count is 50.

Filtering

^ Whitelist Rules

Index

Description

Source Address ?

Click **+** to add filtering rules. The maximum count is 20. The window is displayed as below when defaulting “All” or choosing “ICMP” as the protocol. Here take “All” as an example.

Filtering

^ Filtering Rules

Index	<input type="text" value="1"/>
Description	<input type="text"/>
Source Address	<input type="text"/> ?
Source MAC	<input type="text"/> ?
Target Address	<input type="text"/> ?
Protocol	All v
Action	Drop v

The window is displayed as below when choosing “TCP”, “UDP” or “TCP-UDP” as the protocol. Here take “TCP” as an example.

^ Filtering Rules

Index	<input type="text" value="1"/>
Description	<input type="text"/>
Source Address	<input type="text"/> ?
Source Port	<input type="text"/> ?
Source MAC	<input type="text"/> ?
Target Address	<input type="text"/> ?
Target Port	<input type="text"/> ?
Protocol	TCP v
Action	Drop v

Filtering		
Item	Description	Default
General Settings		
Enable Filtering	Click the toggle button to enable/disable the filtering option.	ON
Default Filtering Policy	Select from “Accept” or “Drop”. Cannot be changed when filtering rules table is not empty. <ul style="list-style-type: none"> Accept: Router will accept all the connecting requests except the hosts which fit the drop filter list Drop: Router will drop all the connecting requests except the hosts which fit the accept filter list 	Accept
Access Control Settings		
Enable Remote SSH Access	Click the toggle button to enable/disable this option. When enabled, the Internet user can access the router remotely via SSH.	OFF
Enable Local SSH Access	Click the toggle button to enable/disable this option. When enabled, the LAN user can access the router locally via SSH.	ON

Filtering		
Item	Description	Default
Enable Remote Telnet Access	Click the toggle button to enable/disable this option. When enabled, the Internet user can access the router remotely via Telnet.	OFF
Enable Local Telnet Access	Click the toggle button to enable/disable this option. When enabled, the LAN user can access the router locally via Telnet.	ON
Enable Remote HTTP Access	Click the toggle button to enable/disable this option. When enabled, the Internet user can access the router remotely via HTTP.	OFF
Enable Local HTTP Access	Click the toggle button to enable/disable this option. When enabled, the LAN user can access the router locally via HTTP.	ON
Enable Remote HTTPS Access	Click the toggle button to enable/disable this option. When enabled, the Internet user can access the router remotely via HTTPS.	ON
Enable Remote Ping Respond	Click the toggle button to enable/disable this option. When enabled, the router will reply to the Ping requests from other hosts on the Internet.	ON
Enable DOS Defending	Click the toggle button to enable/disable this option. When enabled, the router will defend the DOS. Dos attack is an attempt to make a machine or network resource unavailable to its intended users.	ON
Enable Remote IP Forwarding	Click the toggle button to enable/disable this option. When enabled, the Internet date can forward via router.	ON
Enable Console	Click the toggle button to enable/disable this option. When enabled, the user can access the router via Console.	ON
Enable the vpn_nat traversal	Click the toggle button to enable/disable this option. When enabled, the router automatically modifies the IP address of the VPN header received by WAN/WWAN to the IP address of the device under LAN port and sends it out.	OFF
Whitelist Rules		
Item	Description	Default
Index	Indicate the ordinal of the list.	--
Description	Enter a description for this whitelist rule.	Null
Source Address	Defines if access is allowed from one or a range of IP addresses which are defined by Source IP Address, or every IP addresses.	Null
Filtering Rules		
Index	Indicate the ordinal of the list.	--
Description	Enter a description for this filtering rule.	Null
Source Address	Defines if access is allowed from one or a range of IP addresses which are defined by Source IP Address, or every IP addresses.	Null
Source Port	Specify an access originator and enter its source port.	Null
Source MAC	Enter the MAC address of the defined source IP address.	Null
Target Address	Defines if access is allowed to one or a range of IP addresses which are defined by Target IP Address, or every IP addresses.	Null
Target Port	Enter the target port which the access originator wants to access.	Null
Protocol	Select from "All", "TCP", "UDP", "ICMP" or "TCP-UDP". Note: It is recommended that you choose "All" if you don't know which protocol of your application to use.	All

Filtering		
Item	Description	Default
Action	Select from "Accept" or "Drop". <ul style="list-style-type: none"> Accept: When Default Filtering Policy is drop, router will drop all the connecting requests except the hosts which fit this accept filtering list Drop: When Default Filtering Policy is accept, router will accept all the connecting requests except the hosts which fit this drop filtering list 	Drop

Port Mapping

Port mapping is defined manually in routers, and all data received from certain ports of the public network is forwarded to a certain port of an IP in the intranet. Click **Network > Firewall > Port Mapping** to display as follows:

Filtering	Port Mapping	Custom Rules	DMZ	Status		
^ Port Mapping Rules						
Index	Description	Internet Port	Local IP	Local Port	Protocol	+

Click **+** to add port mapping rules. The maximum rule count is 50.

Port Mapping

^ Port Mapping Rules

Index:

Description:

Remote IP: ?

Internet Port: ?

Local IP:

Local Port: ?

Protocol: v

Port Mapping Rules		
Item	Description	Default
Index	Indicate the ordinal of the list.	--
Description	Enter a description for this port mapping.	Null
Remote IP	Specify the host or network which can access to the local IP address. Empty means unlimited. e.g. 10.10.10.10/255.255.255.255 or 192.168.1.0/24	Null
Internet Port	Set the internet port of router which can be accessed by other hosts from internet.	Null
Local IP	Enter router's LAN IP which will forward to the internet port of router.	Null

Port Mapping Rules		
Item	Description	Default
Local Port	Enter the port of router's LAN IP.	Null
Protocol	Select from "TCP", "UDP" or "TCP-UDP" as your application required.	TCP-UDP

Custom Rules

"Custom Rules" meets customer's demand for personal filtering of IP package, filter data usage of a website for example. Users can add any iptables rules which meet the iptables rule format standard in this list.

Filtering | Port Mapping | **Custom Rules** | DMZ | Status

^ Custom Iptables Rules

Index	Description	Rule	
			+

Click **+** to add custom rules. The maximum rule count is 50.

Custom Rules

^ Custom Iptables Rule

Index

Description

Rule ?

Custom Iptables Rules		
Item	Description	Default
Index	Indicate the ordinal of the list.	--
Description	Enter a description for this custom rule.	Null
Rule	Specify one custom rule.	Null

DMZ

DMZ (Demilitarized Zone), namely the isolation zone, also known as the demilitarized zone. It is a buffer between a non-security system and a security system in order to solve the problem that the access users of the external network cannot access the internal network server after installing the firewall. The DMZ host is an intranet host that has open access to all ports except those occupied and forwarded.

Click "**Network > Firewall > DMZ**" to display as follows:

Filtering | Port Mapping | Custom Rules | **DMZ** | Status

^ DMZ Settings

Enable DMZ ON OFF

Host IP Address

Source IP Address ?

DMZ Settings		
Item	Description	Default
Enable DMZ	Click the toggle button to enable/disable DMZ. DMZ host is a host on the internal network that has all ports exposed, except those ports otherwise forwarded.	OFF
Host IP Address	Enter the IP address of the DMZ host on your internal network.	Null
Source IP Address	Set the address which can talk to the DMZ host. 0.0.0.0 means for any addresses.	Null

Status

This window allows you to view the status of chain input, chain forward and chain output.

Filtering	Port Mapping	Custom Rules	DMZ	Status			
^ Chain Input							
Index	Packets	Target	Protocol	In	Out	Source	Destination
1	0	DROP	tcp	wwan	*	0.0.0.0/0	0.0.0.0/0
2	0	DROP	tcp	wwan	*	0.0.0.0/0	0.0.0.0/0
3	0	DROP	tcp	wwan	*	0.0.0.0/0	0.0.0.0/0
4	0	REJECT	tcp	*	*	0.0.0.0/0	0.0.0.0/0
5	52	ACCEPT	tcp	*	*	0.0.0.0/0	0.0.0.0/0
6	0	DROP	tcp	*	*	0.0.0.0/0	0.0.0.0/0
7	0	ACCEPT	tcp	*	*	0.0.0.0/0	0.0.0.0/0
8	0	DROP	tcp	*	*	0.0.0.0/0	0.0.0.0/0
9	0	ACCEPT	icmp	*	*	0.0.0.0/0	0.0.0.0/0
10	0	DROP	icmp	*	*	0.0.0.0/0	0.0.0.0/0
^ Chain Forward							
Index	Packets	Target	Protocol	In	Out	Source	Destination
1	0	TCPMSS	tcp	*	*	0.0.0.0/0	0.0.0.0/0
^ Chain Output							
Index	Packets	Target	Protocol	In	Out	Source	Destination

3.16 Network > IP Passthrough

Click **Network > IP Passthrough > IP Passthrough** to enable or disable the IP Pass-through option.

IP Passthrough
^ General Settings
Enable <input type="checkbox"/> OFF

If router enables the IP Pass-through, the terminal device (such as PC) will enable the DHCP Client mode and connect to LAN port of the router; and after the router dial up successfully, the PC will automatically obtain the IP address and DNS server address which assigned by ISP.

3.17 VPN > IPsec

This section allows you to set the IPsec and the related parameters. Internet Protocol Security (IPsec) is a protocol suite for secure Internet Protocol (IP) communications that works by authenticating and encrypting each IP packet of a communication session.

Click **Virtual Private Network > IPsec > General** to set IPsec parameters

General

General Settings @ General		
Item	Description	Default
Keepalive	Set the keepalive time, measured in seconds. The router will send packets to NAT server every keepalive time to avoid record remove from the NAT list.	60
Debug Enable	Click the toggle button to enable/disable this option. Enable for IPsec VPN information output to the debug port.	OFF

Tunnel

Click **+** to add tunnel settings. The maximum count is 6.

Tunnel

^ **General Settings**

Index

Enable ON OFF

Description

Gateway ?

Mode Tunnel v

Protocol ESP v

Local Subnet ?

Remote Subnet ?

General Settings @ Tunnel		
Item	Description	Default
Index	Indicate the ordinal of the list.	--
Enable	Click the toggle button to enable/disable this IPsec tunnel.	ON
Description	Enter a description for this IPsec tunnel.	Null
Router	Enter the address of remote side IPsec VPN server. 0.0.0.0 represents for any address.	Null
Mode	Select from "Tunnel" and "Transport". <ul style="list-style-type: none"> Tunnel: Commonly used between routers, or at an end-station to a router, the router acting as a proxy for the hosts behind it Transport: Used between end-stations or between an end-station and a router, if the router is being treated as a host-for example, an encrypted Telnet session from a workstation to a router, in which the router is the actual destination 	Tunnel
Protocol	Select the security protocols from "ESP" and "AH". <ul style="list-style-type: none"> ESP: Use the ESP protocol AH: Use the AH protocol 	ESP
Local Subnet	Enter the local subnet's address with mask protected by IPsec, e.g. 192.168.1.0/24	Null
Remote Subnet	Enter the remote subnet's address with mask protected by IPsec, e.g. 10.8.0.0/24	Null
Link binding	Select the link to build Ipsec.	Unbound

The window is displayed as below when choosing "PSK" as the authentication type.

^ IKE Settings

IKE Type	IKEv1	v
Negotiation Mode	Main	v
Authentication Algorithm	MD5	v
Encryption Algorithm	3DES	v
IKE DH Group	DHgroup2	v
Authentication Type	PSK	v
PSK Secret		
Local ID Type	Default	v
Remote ID Type	Default	v
IKE Lifetime	86400	?

The window is displayed as below when choosing “CA” as the authentication type.

^ IKE Settings

IKE Type	IKEv1	v
Negotiation Mode	Main	v
Authentication Algorithm	MD5	v
Encryption Algorithm	3DES	v
IKE DH Group	DHgroup2	v
Authentication Type	CA	v
Private Key Password		
IKE Lifetime	86400	?

The window is displayed as below when choosing “xAuth PSK” as the authentication type.

^ IKE Settings

IKE Type	IKEv1	v
Negotiation Mode	Main	v
Authentication Algorithm	MD5	v
Encryption Algorithm	3DES	v
IKE DH Group	DHgroup2	v
Authentication Type	xAuth PSK	v
PSK Secret		
Local ID Type	Default	v
Remote ID Type	Default	v
Username		?
Password		?
IKE Lifetime	86400	?

The window is displayed as below when choosing “xAuth CA” as the authentication type.

^ IKE Settings

IKE Type ▼

Negotiation Mode ▼

Authentication Algorithm ▼

Encryption Algorithm ▼

IKE DH Group ▼

Authentication Type ▼

Private Key Password

Username ?

Password ?

IKE Lifetime ?

IKE Settings		
Item	Description	Default
IKE Type	Select from “IKEv1” and “IKEv2”.	IKEv1
Negotiation Mode	Select from “Main” and “Aggressive” for the IKE negotiation mode in phase 1. If the IP address of one end of an IPsec tunnel is obtained dynamically, the IKE negotiation mode must be aggressive. In this case, SAs can be established as long as the username and password are correct.	Main
Authentication Algorithm	Select from “MD5”, “SHA1”, “SHA2 256” or “SHA2 512” to be used in IKE negotiation.	MD5
Encrypt Algorithm	Select from “3DES”, “AES128”, “AES192” and “AES256” to be used in IKE negotiation. <ul style="list-style-type: none"> 3DES: Use 168-bit 3DES encryption algorithm in CBC mode AES128: Use 128-bit AES encryption algorithm in CBC mode AES128: Use 192-bit AES encryption algorithm in CBC mode AES256: Use 256-bit AES encryption algorithm in CBC mode 	3DES
IKE DH Group	Select from “DHgroup1”, “DHgroup2”, “DHgroup5”, “DHgroup14”, “DHgroup15”, “DHgroup16”, “DHgroup17” or “DHgroup18” to be used in key negotiation phase 1.	DHgroup2
Authentication Type	Select from “PSK”, “CA”, “xAuth PSK” and “xAuth CA” to be used in IKE negotiation. <ul style="list-style-type: none"> PSK: Pre-shared Key CA: Certification Authority xAuth: Extended Authentication to AAA server 	PSK
PSK Secret	Enter the pre-shared key.	Null
Local ID Type	Select from “Default”, “FQDN” and “User FQDN” for IKE negotiation. <ul style="list-style-type: none"> Default: Uses an IP address as the ID in IKE negotiation FQDN: Uses an FQDN type as the ID in IKE negotiation. If this option is selected, type a name without any at sign (@) for the local security router, e.g., test.robustel.com 	Default

IKE Settings		
Item	Description	Default
	<ul style="list-style-type: none"> User FQDN: Uses a user FQDN type as the ID in IKE negotiation. If this option is selected, type a name string with a sign "@" for the local security router, e.g., test@robustel.com 	
Remote ID Type	Select from "Default", "FQDN" and "User FQDN" for IKE negotiation. <ul style="list-style-type: none"> Default: Uses an IP address as the ID in IKE negotiation FQDN: Uses an FQDN type as the ID in IKE negotiation. If this option is selected, type a name without any at sign (@) for the local security router, e.g., test.robustel.com User FQDN: Uses a user FQDN type as the ID in IKE negotiation. If this option is selected, type a name string with a sign "@" for the local security router, e.g., test@robustel.com 	Default
IKE Lifetime	Set the lifetime in IKE negotiation. Before an SA expires, IKE negotiates a new SA. As soon as the new SA is set up, it takes effect immediately and the old one will be cleared automatically when it expires.	86400
Private Key Password	Enter the private key under the "CA" and "xAuth CA" authentication types.	Null
Username	Enter the username used for the "xAuth PSK" and "xAuth CA" authentication types.	Null
Password	Enter the password used for the "xAuth PSK" and "xAuth CA" authentication types.	Null

If click **VPN > IPsec > Tunnel > General Settings**, and choose **ESP** as protocol. The specific parameter configuration is shown as below.

^ SA Settings

Encrypt Algorithm v

Authentication Algorithm v

PFS Group v

SA Lifetime ?

DPD Interval ?

DPD Failures ?

If choose **AH** as protocol, the window of SA Settings is displayed as below.

^ **General Settings**

Index

Enable ON OFF

Description

Gateway ?

Mode v

Protocol v

Local Subnet ?

Remote Subnet ?

^ **SA Settings**

Authentication Algorithm v

PFS Group v

SA Lifetime ?

DPD Interval ?

DPD Failures ?

^ **Advanced Settings**

Enable Compression ON OFF

Expert Options ?

SA Settings		
Item	Description	Default
Encrypt Algorithm	Select from "3DES", "AES128", "AES192" or "AES256" when you select "ESP" in "Protocol". Higher security means more complex implementation and lower speed. DES is enough to meet general requirements. Use 3DES when high confidentiality and security are required.	3DES
Authentication Algorithm	Select from "MD5", "SHA1", "SHA2 256" or "SHA2 512" to be used in SA negotiation.	MD5
PFS Group	Select from "PFS(N/A)", "DHgroup1", "DHgroup2", "DHgroup5", "DHgroup14", "DHgroup15", "DHgroup16", "DHgroup17" or "DHgroup18" to be used in SA negotiation.	DHgroup2
SA Lifetime	Set the IPsec SA lifetime. When negotiating to set up IPsec SAs, IKE uses the smaller one between the lifetime set locally and the lifetime proposed by the peer.	28800
DPD Interval	Set the interval after which DPD is triggered if no IPsec protected packets is received from the peer. DPD is a Dead peer detection. DPD irregularly detects dead IKE peers. When the local end sends an IPsec packet, DPD checks the time the last IPsec packet was received from the peer. If the time exceeds the DPD interval, it sends a DPD hello to the peer. If the local end	60

SA Settings		
Item	Description	Default
	receives no DPD acknowledgment within the DPD packet retransmission interval, it retransmits the DPD hello. If the local end still receives no DPD acknowledgment after having made the maximum number of retransmission attempts, it considers the peer already dead, and clears the IKE SA and the IPsec SAs based on the IKE SA.	
DPD Failures	Set the timeout of DPD (Dead Peer Detection) packets.	180
Advanced Settings		
Enable Compression	Click the toggle button to enable/disable this option. Enable to compress the inner headers of IP packets.	OFF
Expert Options	Add more PPP configuration options here, format: config-desc;config-desc, e.g. protostack=netkey;plutodebug=none	Null

Status

This section allows you to view the status of the IPsec tunnel.

General	Tunnel	Status	x509
^ IPsec Tunnel Status			
Index	Description	Status	Uptime

x509

User can upload the X509 certificates for the IPsec tunnel in this section.

General	Tunnel	Status	x509
^ X509 Settings ?			
Tunnel Name		Tunnel 1 v	
Local Certificate		Choose File No file chosen ↑	
Remote Certificate		Choose File No file chosen ↑	
Private Key		Choose File No file chosen ↑	
^ Certificate Files			
Index	File Name	File Size	Modification Time

x509		
Item	Description	Default
X509 Settings		
Tunnel Name	Choose a valid tunnel.	Tunnel 1
Local Certificate	Click on “Choose File” to locate the certificate file from local computer, and then import this file into your router.	Null
Remote Certificate	Click on “Choose File” to locate the certificate file from remote computer, and then import this file into your router.	Null
Private Key	Click on “Choose File” to locate the private key file.	Null
Certificate Files		

x509		
Item	Description	Default
X509 Settings		
Index	Indicate the ordinal of the list.	--
Filename	Show the imported certificate's name.	Null
File Size	Show the size of the certificate file.	Null
Last Modification	Show the timestamp of that the last time to modify the certificate file.	Null

3.18 VPN > OpenVPN

This section allows you to set the OpenVPN and the related parameters. OpenVPN is an open-source software application that implements virtual private network (VPN) techniques for creating secure point-to-point or site-to-site connections in routed or bridged configurations and remote access facilities. Router supports point-to-point and point-to-points connections.

OpenVPN

OpenVPN							
Status		x509					
^ Tunnel Settings							
Index	Enable	Description	Mode	Protocol	Server Address	Interface Type	+

Click **+** to add tunnel settings. The maximum count is 3. The window is displayed as below when choosing “None” as the authentication type. By default, the mode is “Client”.

General Settings

Index	<input type="text" value="1"/>
Enable	<input checked="" type="checkbox"/> ON <input type="checkbox"/> OFF
Description	<input type="text"/>
Mode	<input type="text" value="Client"/> v
Protocol	<input type="text" value="UDP"/> v
Server Address	<input type="text"/>
Server Port	<input type="text" value="1194"/>
Interface Type	<input type="text" value="TUN"/> v
Authentication Type	<input type="text" value="None"/> v ?
Renegotiation Interval	<input type="text" value="86400"/> ?
Keepalive Interval	<input type="text" value="20"/> ?
Keepalive Timeout	<input type="text" value="120"/> ?
Enable Compression	<input checked="" type="checkbox"/> ON <input type="checkbox"/> OFF
Enable NAT	<input type="checkbox"/> ON <input checked="" type="checkbox"/> OFF
Verbose Level	<input type="text" value="0"/> v ?

The window is displayed as below when choosing “P2P” as the mode.

^ General Settings

Index	<input type="text" value="1"/>
Enable	<input checked="" type="checkbox"/> ON <input type="checkbox"/> OFF
Description	<input type="text"/>
Mode	<input type="text" value="P2P"/> v
Protocol	<input type="text" value="UDP"/> v
Server Address	<input type="text"/>
Server Port	<input type="text" value="1194"/>
Interface Type	<input type="text" value="TUN"/> v
Authentication Type	<input type="text" value="None"/> v ?
Local IP	<input type="text" value="10.8.0.1"/>
Remote IP	<input type="text" value="10.8.0.2"/>
Keepalive Interval	<input type="text" value="20"/> ?
Keepalive Timeout	<input type="text" value="120"/> ?
Enable Compression	<input checked="" type="checkbox"/> ON <input type="checkbox"/> OFF
Enable NAT	<input type="checkbox"/> ON <input checked="" type="checkbox"/> OFF
Verbose Level	<input type="text" value="0"/> v ?

The window is displayed as below when choosing “Preshared” as the authentication type.

^ General Settings

Index	<input type="text" value="1"/>
Enable	<input checked="" type="checkbox"/> ON <input type="checkbox"/> OFF
Description	<input type="text"/>
Mode	<input type="text" value="Client"/> v
Protocol	<input type="text" value="UDP"/> v
Server Address	<input type="text"/>
Server Port	<input type="text" value="1194"/>
Interface Type	<input type="text" value="TUN"/> v
Authentication Type	<input type="text" value="Preshared"/> v ?
Encrypt Algorithm	<input type="text" value="BF"/> v
Renegotiation Interval	<input type="text" value="86400"/> ?
Keepalive Interval	<input type="text" value="20"/> ?
Keepalive Timeout	<input type="text" value="120"/> ?
Enable Compression	<input checked="" type="checkbox"/> ON <input type="checkbox"/> OFF
Enable NAT	<input type="checkbox"/> ON <input checked="" type="checkbox"/> OFF
Verbose Level	<input type="text" value="0"/> v ?

The window is displayed as below when choosing “Password” as the authentication type.

^ General Settings

Index	<input type="text" value="1"/>
Enable	<input checked="" type="checkbox"/> ON <input type="checkbox"/> OFF
Description	<input type="text"/>
Mode	<input type="text" value="Client"/> v
Protocol	<input type="text" value="UDP"/> v
Server Address	<input type="text"/>
Server Port	<input type="text" value="1194"/>
Interface Type	<input type="text" value="TUN"/> v
Authentication Type	<input type="text" value="Password"/> v ?
Username	<input type="text"/>
Password	<input type="text"/>
Encrypt Algorithm	<input type="text" value="BF"/> v
Renegotiation Interval	<input type="text" value="86400"/> ?
Keepalive Interval	<input type="text" value="20"/> ?
Keepalive Timeout	<input type="text" value="120"/> ?
Enable Compression	<input checked="" type="checkbox"/> ON <input type="checkbox"/> OFF
Enable NAT	<input type="checkbox"/> ON <input checked="" type="checkbox"/> OFF
Verbose Level	<input type="text" value="0"/> v ?

The window is displayed as below when choosing “X509CA” as the authentication type.

^ General Settings

Index	<input type="text" value="1"/>
Enable	<input checked="" type="checkbox"/> ON <input type="checkbox"/> OFF
Description	<input type="text"/>
Mode	<input type="text" value="Client"/> v
Protocol	<input type="text" value="UDP"/> v
Server Address	<input type="text"/>
Server Port	<input type="text" value="1194"/>
Interface Type	<input type="text" value="TUN"/> v
Authentication Type	<input type="text" value="X509CA"/> v ?
Encrypt Algorithm	<input type="text" value="BF"/> v
Renegotiation Interval	<input type="text" value="86400"/> ?
Keepalive Interval	<input type="text" value="20"/> ?
Keepalive Timeout	<input type="text" value="120"/> ?
Private Key Password	<input type="text"/>
Enable Compression	<input checked="" type="checkbox"/> ON <input type="checkbox"/> OFF
Enable NAT	<input type="checkbox"/> ON <input checked="" type="checkbox"/> OFF
Verbose Level	<input type="text" value="0"/> v ?

The window is displayed as below when choosing “X509CA Password” as the authentication type.

^ General Settings

Index	<input type="text" value="1"/>
Enable	<input checked="" type="checkbox"/> ON <input type="checkbox"/> OFF
Description	<input type="text"/>
Mode	<input type="text" value="Client"/>
Protocol	<input type="text" value="UDP"/>
Server Address	<input type="text"/>
Server Port	<input type="text" value="1194"/>
Interface Type	<input type="text" value="TUN"/>
Authentication Type	<input type="text" value="X509CA Password"/>
Username	<input type="text"/>
Password	<input type="text"/>
Encrypt Algorithm	<input type="text" value="BF"/>
Renegotiation Interval	<input type="text" value="86400"/> ?
Keepalive Interval	<input type="text" value="20"/> ?
Keepalive Timeout	<input type="text" value="120"/> ?
Private Key Password	<input type="text"/>
Enable Compression	<input checked="" type="checkbox"/> ON <input type="checkbox"/> OFF
Enable NAT	<input type="checkbox"/> ON <input checked="" type="checkbox"/> OFF
Verbose Level	<input type="text" value="0"/> ?

General Settings @ OpenVPN		
Item	Description	Default
Index	Indicate the ordinal of the list.	--
Enable	Click the toggle button to enable/disable this OpenVPN tunnel.	ON
Description	Enter a description for this OpenVPN tunnel.	Null
Mode	Select from “P2P” or “Client”.	Client
Protocol	Select from “UDP”, “TCP-Client” or “TCP-Server”.	UDP
Server Address	Enter the end-to-end IP address or the domain of the remote OpenVPN server.	Null
Server Port	Enter the end-to-end listener port or the listener port of the OpenVPN server.	1194
Interface Type	Select from “TUN”, “TAP” which are two different kinds of device interface for OpenVPN. The difference between TUN and TAP device is that a TUN device is a point-to-point virtual device on network while a TAP device is a virtual device on Ethernet.	TUN

General Settings @ OpenVPN		
Item	Description	Default
Authentication Type	Select from "None", "Preshared", "Password", "X509CA" and "X509CA Password". Note: "None" and "Preshared" authentication type are only working with P2P mode.	None
Username	Enter the username used for "Password" or "X509CA Password" authentication type.	Null
Password	Enter the password used for "Password" or "X509CA Password" authentication type.	Null
Local IP	Enter the local virtual IP.	10.8.0.1
Remote IP	Enter the remote virtual IP.	10.8.0.2
Encrypt Algorithm	Select from "BF", "DES", "DES-EDE3", "AES128", "AES192" and "AES256". <ul style="list-style-type: none"> BF: Use 128-bit BF encryption algorithm in CBC mode DES: Use 64-bit DES encryption algorithm in CBC mode DES-EDE3: Use 192-bit 3DES encryption algorithm in CBC mode AES128: Use 128-bit AES encryption algorithm in CBC mode AES192: Use 192-bit AES encryption algorithm in CBC mode AES256: Use 256-bit AES encryption algorithm in CBC mode 	BF
Renegotiation Interval	Set the renegotiation interval. If connection failed, OpenVPN will renegotiate when the renegotiation interval reached.	86400
Keepalive Interval	Set keepalive (ping) interval to check if the tunnel is active.	20
Keepalive Timeout	Set the keepalive timeout. Trigger OpenVPN restart after n seconds pass without reception of a ping or other packet from remote.	120
Private Key Password	Enter the private key password under the "X509CA" and "X509CA Password" authentication type.	Null
Enable Compression	Click the toggle button to enable/disable this option. Enable to compress the data stream of the header.	ON
Enable NAT	Click the toggle button to enable/disable the NAT option. When enabled, the source IP address of host behind router will be disguised before accessing the remote OpenVPN client.	OFF
Verbose Level	Select the level of the output log and values from 0 to 11. <ul style="list-style-type: none"> 0: No output except fatal errors 1~4: Normal usage range 5: Output R and W characters to the console for each packet read and write 6~11: Debug info range 	0

^ Advanced Settings

Enable HMAC Firewall ON OFF

Enable PKCS#12 ON OFF

Enable nsCertType ON OFF

Expert Options ?

Advanced Settings @ OpenVPN		
Item	Description	Default
Enable HMAC Firewall	Click the toggle button to enable/disable this option. Add an additional layer of HMAC authentication on top of the TLS control channel to protect against DoS attacks.	OFF
Enable PKCS#12	Click the toggle button to enable/disable the PKCS#12 certificate. It is an exchange of digital certificate encryption standard, used to describe personal identity information.	OFF
Enable nsCertType	Click the toggle button to enable/disable nsCertType. Require that peer certificate was signed with an explicit nsCertType designation of "server".	OFF
Expert Options	Enter some other options of OpenVPN in this field. Each expression can be separated by a ','.	Null

Status

This section allows you to view the status of the OpenVPN tunnel.

OpenVPN | **Status** | x509

^ OpenVPN Tunnel Status

Index	Description	Status	Uptime	Local IP
-------	-------------	--------	--------	----------

x509

User can upload the X509 certificates for the OpenVPN in this section.

OpenVPN | Status | **x509**

^ X509 Settings ?

Tunnel Name v

Root CA No file chosen

Certificate File No file chosen

Private Key No file chosen

TLS-Auth Key No file chosen

PKCS#12 Certificate No file chosen

Pre-Share Key No file chosen

^ Certificate Files

Index	File Name	File Size	Modification Time
-------	-----------	-----------	-------------------

x509		
Item	Description	Default
X509 Settings		
Tunnel Name	Choose a valid tunnel.	Tunnel 1
Root CA	Click on “Choose File” to locate the root ca file ,and then import this file into your router.	Null
Certificate File	Click on “Choose File” to locate the certificate file, and then import this file into your router.	
Private Key	Click on “Choose File” to locate the private key file, and then import this file into your router.	
TLS-Auth Key	Click on “Choose File” to locate the tls-auth key file, and then import this file into your router.	
PKCS#12 Certificate	Click on “Choose File” to locate the pkcs#12 certificate file ,and then import this file into your router.	
Pre-Share Key	Click on “Choose File” to locate the pre-share key file , and then import this file into your router.	
Certificate Files		
Index	Indicate the ordinal of the list.	--
Filename	Show the imported certificate’s name.	Null
File Size	Show the size of the certificate file.	Null
Last Modification	Show the timestamp of that the last time to modify the certificate file.	Null

3.19 VPN > GRE

This section allows you to set the GRE and the related parameters. Generic Routing Encapsulation (GRE) is a tunneling protocol that can encapsulate a wide variety of network layer protocols inside virtual point-to-point links over an Internet Protocol network.

GRE

GRE	Status
^ Tunnel Settings	
Index	Enable Description Remote IP Address

Click **+** to add tunnel settings. The maximum count is 5.

GRE

^ **Tunnel Settings**

Index

Enable ON OFF

Description

Remote IP Address

Local Virtual IP Address

Local Virtual Netmask

Remote Virtual IP Address

Enable Default Route ON OFF

Enable NAT ON OFF

Secrets

Tunnel Settings @ GRE		
Item	Description	Default
Index	Indicate the ordinal of the list.	--
Enable	Click the toggle button to enable/disable this GRE tunnel.	ON
Description	Enter a description for this GRE tunnel.	Null
Remote IP Address	Set the remote real IP address of the GRE tunnel.	Null
Local Virtual IP Address	Set the local virtual IP address of the GRE tunnel.	Null
Local Virtual Netmask	Set the local virtual Netmask of the GRE tunnel.	Null
Remote Virtual IP Address	Set the remote virtual IP Address of the GRE tunnel.	Null
Enable Default Route	Click the toggle button to enable/disable this option. When enabled, all the traffics of the router will go through the GRE VPN.	OFF
Enable NAT	Click the toggle button to enable/disable this option. This option must be enabled when router under NAT environment.	Disable
Secrets	Set the key of the GRE tunnel.	Null

Status

This section allows you to view the status of GRE tunnel.

GRE
Status

^ **GRE tunnel status**

Index	Description	Status	Local IP Address	Remote IP Address	Uptime
-------	-------------	--------	------------------	-------------------	--------

3.20 Services > Syslog

This section allows you to set the syslog parameters. The system log of the router can be saved in the local, also supports to be sent to remote log server and specified application debugging. By default, the “Log to Remote” option is disabled.

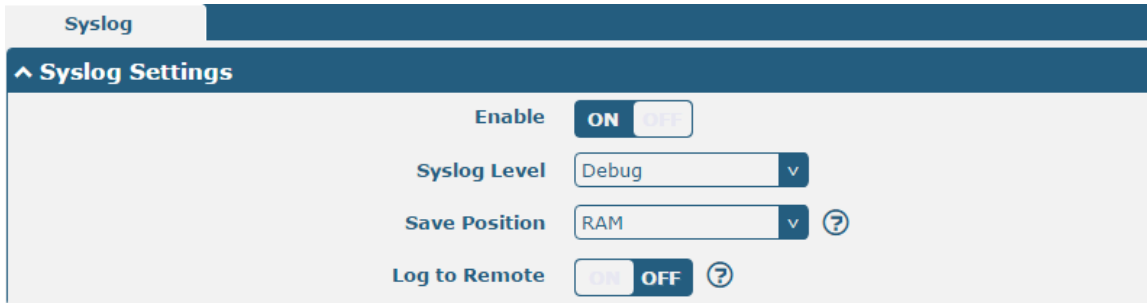

The window is displayed as below when enabling the “Log to Remote” option.



Syslog Settings		
Item	Description	Default
Enable	Click the toggle button to enable/disable the Syslog settings option.	OFF
Syslog Level	Select from “Debug”, “Info”, “Notice”, “Warning” or “Error”, which from low to high. The lower level will output more syslog in detail.	Debug
Save Position	Select the save position from “RAM”, “NVM” or “Console”. Choose “RAM”, the data will be cleared after reboot. Note: It's not recommended that saving syslog to NVM (Non-Volatile Memory) for a long time.	RAM
Log to Remote	Click the toggle button to enable/disable this option. Enable to allow router sending syslog to the remote syslog server. You need to enter the IP and Port of the syslog server.	OFF
Add Identifier	Click the toggle button to enable/disable this option. When enabled, you can add serial number to syslog message which used for loading Syslog to RobustLink.	OFF
Remote IP Address	Enter the IP address of syslog server when enabling the “Log to Remote” option.	Null
Remote Port	Enter the port of syslog server when enabling the “Log to Remote” option.	514

3.21 Services > Event

This section allows you to set the router events. It can be configured to send event alarms for SMS, or it can report router events through SNMP-TRAP and RobustLink.

Event Notification Query

^ General Settings

Signal Quality Threshold ?

General Settings @ Event		
Item	Description	Default
Signal Quality Threshold	Set the threshold for signal quality. Router will generate a log event when the actual threshold is less than the specified threshold. 0 means disable this option.	0

Event Notification Query

^ Event Notification Group Settings

Index	Description	Send SMS	Send Email	Save to NVM	
					+

Click **+** button to add an Event parameters.

^ General Settings

Index

Description

Send SMS ON OFF

Phone Number ?

Send Email ON OFF

Email Addresses ?

Save to NVM ON OFF ?

^ Event Selection
?

System Startup	<input type="checkbox"/> OFF
System Reboot	<input type="checkbox"/> OFF
System Time Update	<input type="checkbox"/> OFF
Configuration Change	<input type="checkbox"/> OFF
Cellular Network Type Change	<input type="checkbox"/> OFF
Cellular Data Stats Clear	<input type="checkbox"/> OFF
Cellular Data Traffic Overflow	<input type="checkbox"/> OFF
Poor Signal Quality	<input type="checkbox"/> OFF
Link Switching	<input type="checkbox"/> OFF
WAN Up	<input type="checkbox"/> OFF
WAN Down	<input type="checkbox"/> OFF
WLAN Up	<input type="checkbox"/> OFF
WLAN Down	<input type="checkbox"/> OFF
WWAN Up	<input type="checkbox"/> OFF
WWAN Down	<input type="checkbox"/> OFF
IPSec Connection Up	<input type="checkbox"/> OFF
IPSec Connection Down	<input type="checkbox"/> OFF
OpenVPN Connection Up	<input type="checkbox"/> OFF
OpenVPN Connection Down	<input type="checkbox"/> OFF
LAN Port Link Up	<input type="checkbox"/> OFF
LAN Port Link Down	<input type="checkbox"/> OFF
USB Device Connect	<input type="checkbox"/> OFF
USB Device Remove	<input type="checkbox"/> OFF
DDNS Update Success	<input type="checkbox"/> OFF
DDNS Update Fail	<input type="checkbox"/> OFF
Received SMS	<input type="checkbox"/> OFF
SMS Command Execute	<input type="checkbox"/> OFF
DI 1 ON	<input type="checkbox"/> OFF
DI 1 OFF	<input type="checkbox"/> OFF
DI 1 Counter Overflow	<input type="checkbox"/> OFF

General Settings @ Notification		
Item	Description	Default
Index	Indicate the ordinal of the list.	--

Description	Enter a description for this group.	Null
Sent SMS	Click the toggle button to enable/disable this option. When enabled, the router will send notification to the specified phone numbers via SMS if event occurs. Set the related phone number in “3.24 Services > Email”, and use ‘;’ to separate each number.	OFF
Phone Number	Enter the phone numbers used for receiving event notification. Use a semicolon (;) to separate each number.	Null
Send Email	Click the toggle button to enable/disable this option. When enabled, the router will send notification to the specified email box via Email if event occurs. Set the related email address in “3.24 Services > Email”.	OFF
Email Addresses	Enter the email addresses used for receiving event notification. Use a space to separate each address.	Null
Save to NVM	Click the toggle button to enable/disable this option. Enable to save event to nonvolatile memory.	OFF

In the following window you can query various types of events record. Click **Refresh** to query filtered events while click **Clear** to clear the event records in the window.

Event Details		
Item	Description	Default
Save Position	Select the events' save position from “RAM” or “NVM”. <ul style="list-style-type: none"> RAM: Random-access memory NVM: Non-Volatile Memory 	RAM

Filter Message	Event will be filtered according to the Filter Message that the user set. Click the “Refresh” button, the filtered event will be displayed in the follow box. Use “&” to separate more than one filter message, such as message1&message2.	Null
----------------	--	------

3.22 Services > NTP

This section allows you to set the related NTP (Network Time Protocol) parameters, including Time zone, NTP Client and NTP Server.

NTP

Status

^ Timezone Settings

Time Zone

Expert Setting ?

^ NTP Client Settings

Enable ON OFF

Primary NTP Server

Secondary NTP Server

NTP Update Interval ?

^ NTP Server Settings

Enable ON OFF

NTP		
Item	Description	Default
Timezone Settings		
Time Zone	Click the drop down list to select the time zone you are in.	UTC +08:00
Expert Setting	Specify the time zone with Daylight Saving Time in TZ environment variable format. The Time Zone option will be ignored in this case.	Null
NTP Client Settings		
Enable	Click the toggle button to enable/disable this option. Enable to synchronize time with the NTP server.	ON
Primary NTP Server	Enter primary NTP Server’s IP address or domain name.	pool.ntp.org
Secondary NTP Server	Enter secondary NTP Server’s IP address or domain name.	Null
NTP Update interval	Enter the interval (minutes) which NTP client synchronize the time from NTP server. Minutes wait for next update, and 0 means update only once.	0
NTP Server Settings		
Enable	Click the toggle button to enable the NTP server option.	OFF

This window allows you to view the current time of router and also synchronize the router time. Click **Sync** button to synchronize the router time with PC's.



3.23 Services > SMS

This section allows you to set SMS parameters. Router supports SMS management, and user can control and configure their routers by sending SMS. For more details about SMS control, refer to **4.2.2 SMS Remote Control**.

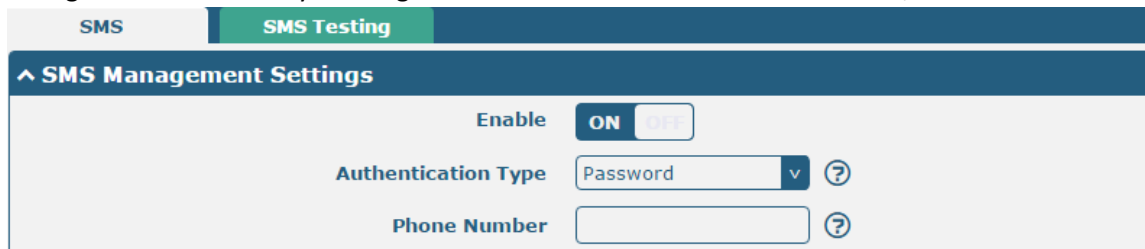

SMS Management Settings		
Item	Description	Default
Enable	Click the toggle button to enable/disable the SMS Management option. Note: If this option is disabled, the SMS configuration is invalid.	ON
Authentication Type	Select Authentication Type from “Password”, “Phonenum” or “Both”. <ul style="list-style-type: none"> • Password: Use the same username and password as WEB manager for authentication. For example, the format of the SMS should be “username: password; cmd1; cmd2; ...” • Phonenum: Use the Phone number for authenticating, and user should set the Phone Number that is allowed for SMS management. The format of the SMS should be “cmd1; cmd2; ...” • Both: Use both the “Password” and “Phonenum” for authentication. User should set the Phone Number that is allowed for SMS management. The format of the SMS should be “username: password; cmd1; cmd2; ...” 	Password
Phone Number	Set the phone number used for SMS management, and use ‘;’ to separate each number. Note: It can be null when choose “Password” as the authentication type.	Null

User can test the current SMS service whether it is available in this section.

SMS
SMS Testing

^ SMS Testing

Phone Number

Message

Result

SMS Testing		
Item	Description	Default
Phone Number	Enter the specified phone number which can receive the SMS from router.	Null
Message	Enter the message that router will send it to the specified phone number.	Null
Result	The result of the SMS test will be displayed in the result box.	Null
<input style="background-color: #004a7c; color: white; padding: 2px 5px; border: none;" type="button" value="Send"/>	Click the button to send the test message.	--

3.24 Services > Email

Email function supports to send the event notifications to the specified recipient by ways of email.

Email

^ Email Settings

Enable ON OFF

Enable TLS/SSL ON OFF ?

Outgoing Server

Server Port

Timeout ?

Username

Password

From

Subject

Email Settings		
Item	Description	Default
Enable	Click the toggle button to enable/disable the Email option.	OFF

Email Settings		
Item	Description	Default
Enable TLS/SSL	Click the toggle button to enable/disable the TLS/SSL option.	OFF
Outgoing server	Enter the SMTP server IP Address or domain name.	Null
Server port	Enter the SMTP server port.	25
Timeout	Set the max time for sending email to SMTP server. When the server doesn't receive the email over this time, it will try to resend.	10
Username	Enter the username which has been registered from SMTP server.	Null
Password	Enter the password of the username above.	Null
From	Enter the source address of the email.	Null
Subject	Enter the subject of this email.	Null

3.25 Services > DDNS

This section allows you to set the DDNS parameters. The Dynamic DNS function allows you to alias a dynamic IP address to a static domain name, allows you whose ISP does not assign them a static IP address to use a domain name. This is especially useful for hosting servers via your connection, so that anyone wishing to connect to you may use your domain name, rather than having to use your dynamic IP address, which changes from time to time. This dynamic IP address is the WAN IP address of the router, which is assigned to you by your ISP. The service provider defaults to "DynDNS", as shown below.

The screenshot shows the 'DDNS Settings' window. At the top, there are two tabs: 'DDNS' and 'Status'. Below the tabs, there is a section titled '^ DDNS Settings'. It contains an 'Enable' toggle switch set to 'OFF'. Below that is a 'Service Provider' dropdown menu with 'DynDNS' selected and highlighted by a red box. Underneath are input fields for 'Hostname', 'Username', and 'Password'.

When "Custom" service provider chosen, the window is displayed as below.

The screenshot shows the 'DDNS Settings' window with the 'Service Provider' dropdown menu set to 'Custom' and highlighted by a red box. Below it is a 'URL' input field. The 'Enable' toggle switch is still set to 'OFF'.

DDNS Settings		
Item	Description	Default
Enable	Click the toggle button to enable/disable the DDNS option.	OFF
Service Provider	Select the DDNS service from "DynDNS", "NO-IP", "3322" or	DynDNS

	"Custom". Note: the DDNS service only can be used after registered by Corresponding service provider.	
Hostname	Enter the hostname provided by the DDNS server.	Null
Username	Enter the username provided by the DDNS server.	Null
Password	Enter the password provided by the DDNS server.	Null
URL	Enter the URL customized by user.	Null

Click "Status" bar to view the status of the DDNS.

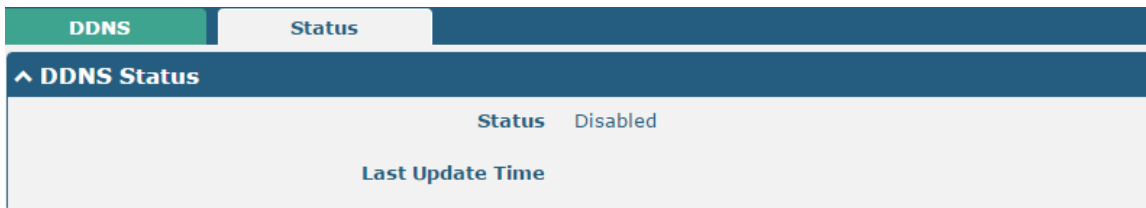

DDNS Status	
Item	Description
Status	Display the current status of the DDNS.
Last Update Time	Display the date and time for the DDNS was last updated successfully.

3.26 Services > SSH

Router supports SSH password access and secret-key access.

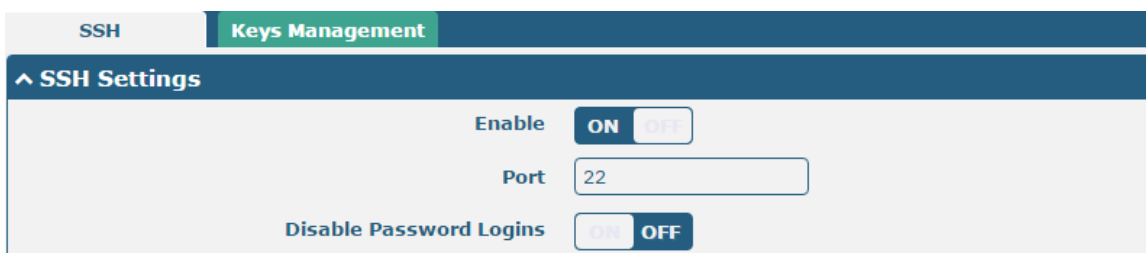

SSH Settings		
Item	Description	Default
Enable	Click the toggle button to enable/disable this option. When enabled, you can access the router via SSH.	OFF
Port	Set the port of the SSH access.	22
Disable Password Logins	Click the toggle button to enable/disable this option. When enabled, you cannot use username and password to access the router via SSH. In this case, only the key can be used for login.	OFF

SSH | Keys Management

^ Import Authorized Keys

Authorized Keys No file chosen

Import Authorized Keys	
Item	Description
Authorized Keys	Click on "Choose File" to locate an authorized key from your computer, and then click "Import" to import this key into your router. Note: This option is valid when enabling the password logins option.

3.27 GPS

This section is used to configure the parameters of GPS. The GPS function of R2110 router can locate and acquire the location information of the device and report it to the designated server.

GPS | Status | Map

^ General Settings

Enable GPS ON OFF

Sync GPS Time ON OFF

^ RS232 Report Settings

Report to RS232 ON OFF

Report GGA Sentence ON OFF

Report VTG Sentence ON OFF

Report RMC Sentence ON OFF

Report GSV Sentence ON OFF

^ GPS Servers

Index	Enable	Protocol	Local Address	Local Port	Server Address	Server Port	
							+

GPS		
Item	Description	Default
General Settings		
Enable	Click the toggle button to ON to enable GPS.	OFF
Synchronized GPS Time	Click the toggle button to ON to synchronize GPS time.	OFF
RS232 Report Data Settings		
Reporting data through RS232	Reporting GPS Information by RS232.	OFF
Reporting GGA	Reporting GGA Information.	OFF

GPS		
Item	Description	Default
General Settings		
Information		
Reporting VTG Information	Reporting VTG Information.	OFF
Reporting RMC Information	Reporting RMC Information.	OFF
Reporting GSV Information	Reporting GSV Information.	OFF

Click the Add button in the GPS server window, and the protocol defaults to "TCP Client" as follows:

The screenshot shows the 'GPS Server Settings' window. The 'Protocol' dropdown menu is set to 'TCP Client'. Other settings include Index: 1, Enable: ON, Server Address: (empty), Server Port: (empty), and various sentence sending options (GGA, VTG, RMC, GSV) all set to OFF. 'Submit' and 'Close' buttons are at the bottom right.

When selecting "TCP Server" as the protocol, the window appears as follows:

This screenshot is identical to the previous one, but the 'Protocol' dropdown menu, which currently shows 'TCP Client', is highlighted with a red rectangular box. This highlights the protocol selection area.

When selecting "UDP" as the protocol, the window appears as follows:

^ Server Settings

Index

Enable ON OFF

Protocol

Server Address

Server Port

Send GGA Sentence ON OFF

Send VTG Sentence ON OFF

Send RMC Sentence ON OFF

Send GSV Sentence ON OFF

GPS Data Forwarding Settings		
Item	Description	Default
Index	Indicate the ordinal of the list.	--
Enable	Click the toggle button to "ON" to enable the GPS data forwarding settings.	ON
Protocol	Select "TCP client", "TCP server" or "UDP" as the protocol. <ul style="list-style-type: none"> TCP Client: When the router acts as a TCP client, it starts up with the TCP server (GPS server). The address of the server supports both IP and domain name. TCP server: The router acts as a TCP server (GPS server) and listens for connection requests from TCP clients. UDP: Router as a UDP client. 	TCP Client
Server address @TCP client	Set the address of the TCP server.	Null
Server port @TCP client	Set the port of the remote TCP server	Null
Local address	Set the local address of the router as a TCP server.	Null
Local port	Set the local port of the router as a TCP server.	Null
Server address @UDP	Set the address of the TCP server	Null
Server port @UDP	Set the port of the remote TCP server.	Null
Send GGA information	Send GGA information in NMEA format	OFF
Send VTG information	Send VTG information in NMEA format	OFF
Send RMC	Send RMC information in NMEA format	OFF

GPS Data Forwarding Settings		
Item	Description	Default
information		
Send GSV information	Send GSV information in NMEA format	OFF

Click the Status bar to view the current GPS status of the router;

GPS
Status
Map

^ GPS Status

Status	Not Fixed
UTC Time	2017-09-15 07:18:23
Last Fixed Time	2017-09-14 12:36:58 UTC
Satellites In Use	4
Satellites In View	12
Latitude	23.1534988
Longitude	113.4013826
Altitude	29.0 m
Speed	1.947 m/s

GPS Status	
Item	Description
Status	Shows the current GPS status of the router.
UTC	Shows the UTC of satellite. Note: UTC is the world's unified time, not local time.
Final positioning time	The time of the last successful positioning.
Number of satellites used	Number of satellites used
Number of visible satellites	Number of visible satellites
Latitude	Shows the Latitude information of the router.
Longitude	Shows the longitude information of the router.
Height	Shows the height information of the router.
Speed	Shows the speed information of the router.

Click the Map bar to view the current geolocation of the router.

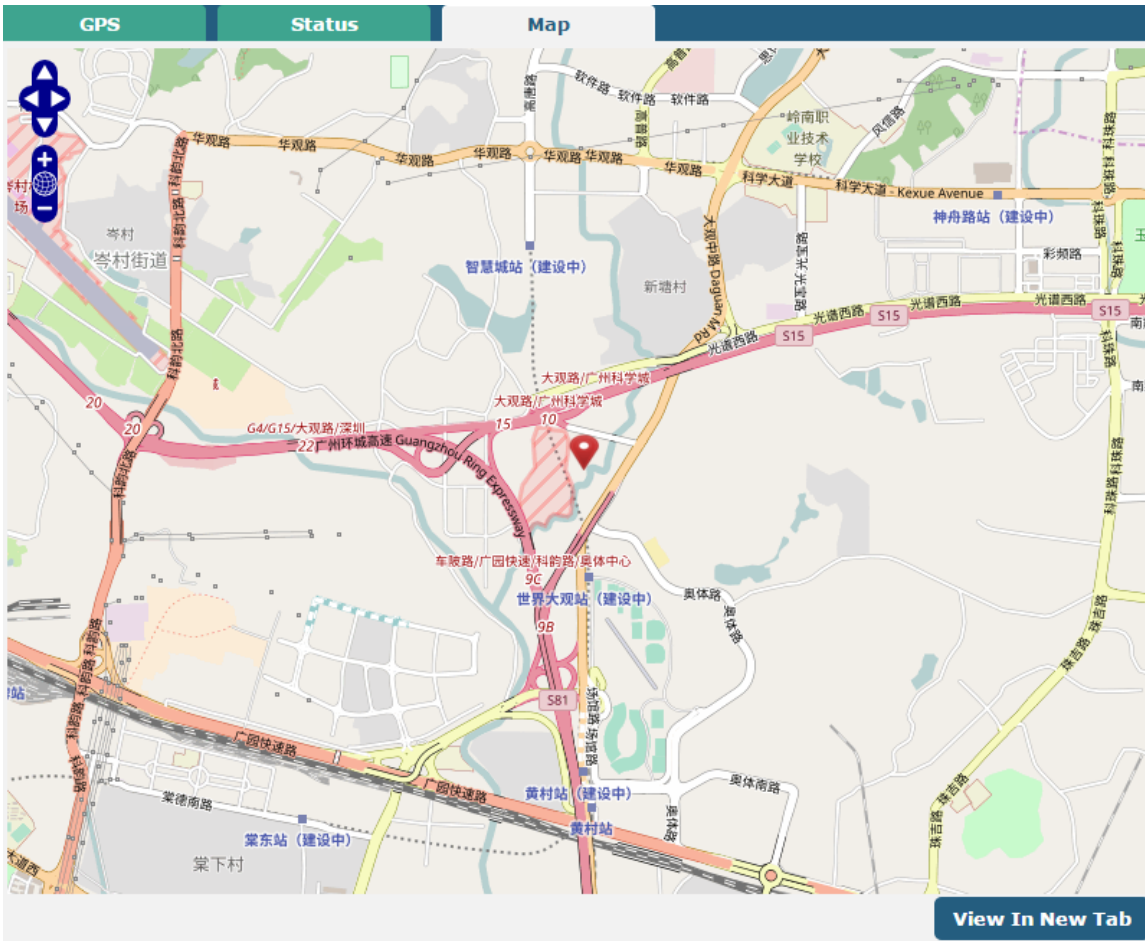

3.28 Ignition

This section is used to configure the parameters of Ignition.

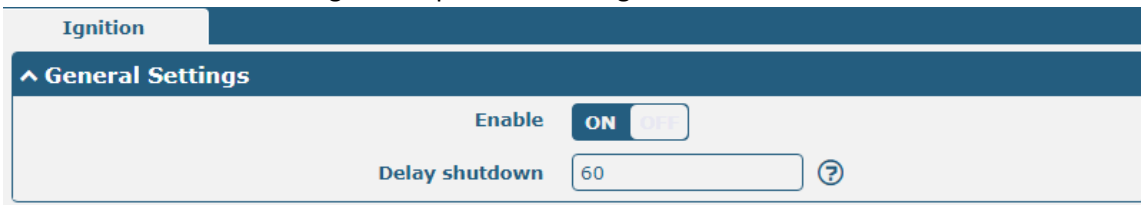

General Settings		
Item	Description	Default
Enable	Click the toggle button to "ON" to enable the Ignition function.	ON
Waiting time	Enter the time in seconds you want to delay power down. The timeout for delayed power down is 60 seconds to 3600 seconds.	60

3.29 Services > Web Server

This section allows you to modify the parameters of Web Server.

Web Server	Certificate Management
^ General Settings	
HTTP Port	<input type="text" value="80"/> ?
HTTPS Port	<input type="text" value="443"/> ?

General Settings @ Web Server		
Item	Description	Default
HTTP Port	Enter the HTTP port number you want to change in router's Web Server. On a Web server, port 80 is the port that the server "listens to" or expects to receive from a Web client. If you configure the router with other HTTP Port number except 80, only adding that port number then you can login router's Web Server.	80
HTTPS Port	Enter the HTTPS port number you want to change in router's Web Server. On a Web server, port 443 is the port that the server "listens to" or expects to receive from a Web client. If you configure the router with other HTTPS Port number except 443, only adding that port number then you can login router's Web Server. Note: HTTPS is more secure than HTTP. In many cases, clients may be exchanging confidential information with a server, which needs to be secured in order to prevent unauthorized access. For this reason, HTTP was developed by Netscape corporation to allow authorization and secured transactions.	443

This section allows you to import the certificate file into the router.

Import Certificate		
Item	Description	Default
Import Type	Select from “CA” and “Private Key”. <ul style="list-style-type: none"> CA: a digital certificate issued by CA center Private Key: a private key file 	CA
HTTPS Certificate	Click on “Choose File” to locate the certificate file from your computer, and then click “Import” to import this file into your router.	--

3.30 Services > Advanced

This section allows you to set the Advanced and parameters.

System Settings		
Item	Description	Default
Device Name	Set the device name to distinguish different devices you have installed; valid characters are a-z, A-Z, 0-9, @, ., -, #, \$, and *.	router
User LED Type	Specify the display type of your USR LED. Select from “None”, “OpenVPN” or “IPsec”. <ul style="list-style-type: none"> None: Meaningless indication, and the LED is off SIM: show the sim status. OpenVPN: USR indicator showing the OpenVPN status IPsec: USR indicator showing the IPsec status 	None

Note: For more details about USR indicator, see “2.2 LED Indicators”.

System
Reboot

^ Periodic Reboot Settings

Periodic Reboot ?

Daily Reboot Time ?

Reboot		
Item	Description	Default
Periodic Reboot	Set the reboot period of the router. 0 means disable.	0
Daily Reboot Time	Set the daily reboot time of the router, you should follow the format as HH:MM, in 24h time frame, otherwise the data will be invalid. Leave it empty means disable.	Null

3.31 System > Debug

This section allows you to check and download the syslog details. Click **Service > System Log > System Log Settings** to open the system log.

Syslog

^ Syslog Details

Log Level v

Filtering ?

```

Feb 27 14:29:07 router user.debug link_manager[842]: target link WWAN1, state Connected
Feb 27 14:29:07 router user.info link_manager[842]: WWAN1 ping test success
Feb 27 14:29:23 router user.debug modemd[876]: +CUSATP:
"D064810301250082028182850F80005500530049004D53615E9475288F0A01807CBE54C163A883508F0A02806C83901A884C8BC18F0A03804F6F6C11670D52A18F0C0480624B673A84254E1A53858F0A05806D4191CF4E13533A8F0A0680727960E0793C5305"
Feb 27 14:31:23 router user.debug modemd[876]: +CUSATP:
"D064810301250082028182850F80005500530049004D53615E9475288F0A01807CBE54C163A883508F0A02806C83901A884C8BC18F0A03804F6F6C11670D52A18F0C0480624B673A84254E1A53858F0A05806D4191CF4E13533A8F0A0680727960E0793C5305"
Feb 27 14:33:23 router user.debug modemd[876]: +CUSATP:
"D064810301250082028182850F80005500530049004D53615E9475288F0A01807CBE54C163A883508F0A02806C83901A884C8BC18F0A03804F6F6C11670D52A18F0C0480624B673A84254E1A53858F0A05806D4191CF4E13533A8F0A0680727960E0793C5305"
Feb 27 14:34:07 router user.debug link_manager[842]: WWAN1 (wwan) start ping test
Feb 27 14:34:07 router user.debug rping[16182]: start ping 8.8.8.8 (wwan)
Feb 27 14:34:07 router user.debug rping[16182]: PING 8.8.8.8 (8.8.8.8) from 10.122.74.11: 16 data bytes
Feb 27 14:34:07 router user.debug rping[16182]: 24 bytes from 8.8.8.8: seq=0 ttl=52 time=324.080 ms
Feb 27 14:34:07 router user.debug rping[16182]:
Feb 27 14:34:07 router user.debug rping[16182]: --- 8.8.8.8 ping statistics ---
Feb 27 14:34:07 router user.debug rping[16182]: 1 packets transmitted, 1 packets received, 0% packet loss
Feb 27 14:34:07 router user.debug rping[16182]: round-trip min/avg/max = 324.080/324.080/324.080 ms
Feb 27 14:34:07 router user.debug link_manager[842]: rcv action ping_success from rping
Feb 27 14:34:07 router user.debug link_manager[842]: target link WWAN1, state Connected
Feb 27 14:34:07 router user.info link_manager[842]: WWAN1 ping test success
Feb 27 14:35:23 router user.debug modemd[876]: +CUSATP:
"D064810301250082028182850F80005500530049004D53615E9475288F0A01807CBE54C163A883508F0A02806C83901A884C8BC18F0A03804F6F6C11670D52A18F0C0480624B673A84254E1A53858F0A05806D4191CF4E13533A8F0A0680727960E0793C5305"
                    
```

v

^ Syslog Files

Index	File Name	File Size	Modification Time	
1	messages	112612	Mon Feb 27 14:35:23 2017	

^ System Diagnostic Data

System Diagnostic Data Generate

System Diagnostic Data Download

Syslog		
Item	Description	Default
Syslog Details		
Log Level	Select from “Debug”, “Info”, “Notice”, “Warn”, “Error” which from low to high. The lower level will output more syslog in detail.	Debug
Filtering	Enter the filtering message based on the keywords. Use “&” to separate more than one filter message, such as “keyword1&keyword2”.	Null
Refresh	Select from “Manual Refresh”, “5 Seconds”, “10 Seconds”, “20 Seconds” or “30 Seconds”. You can select these intervals to refresh the log information displayed in the follow box. If selecting “manual refresh”, you should click the refresh button to refresh the syslog.	Manual Refresh
Clear	Click the button to clear the syslog.	--
Refresh	Click the button to refresh the syslog.	--
Syslog Files		
Syslog Files List	It can show at most 5 syslog files in the list, the files’ name range from message0 to message 4. And the newest syslog file will be placed on the top of the list.	/
System Diagnosing Data		
Generate	Click to generate the syslog diagnosing file.	/
Download	Click to download system diagnosing file.	/

3.32 System > Update

This section allows you to upgrade the firmware of your router. Click **System > Update > System Update**, and click on “Choose File” to locate the firmware file to be used for the upgrade. Once the latest firmware has been chosen, click Update to start the upgrade process. The upgrade process may take several minutes. Do not turn off your Router during the firmware upgrade process.

Note: To access the latest firmware file, please contact your technical support engineer.

^ System Update

File Choose File No file chosen Update

3.33 System > App Center

This section allows you to add some required or customized applications to the router. Import and install your applications to the App Center, and reboot the device according to the system prompts. Each installed application will be displayed under the “Services” menu, while other applications related to VPN will be displayed under the “VPN” menu.

Note: After importing the applications to the router, the page display may have a slight delay due to the browser cache. It is recommended that you clear the browser cache first and log in the router again.





App Center		
Item	Description	Default
App Install		
Install to SD card	Click the toggle button to enable/disable the ability to install the app to the SD card.	OFF
File	Click on “Choose File” to locate the App file from your computer, and then click Install to import this file into your router. Note: File format should be <i>xxx.rpk</i> , e.g. <i>R2110-robustlink-1.0.0.rpk</i> .	--
Installed Apps		
Index	Indicate the ordinal of the list.	--
Name	Show the name of the App.	Null
Version	Show the version of the App.	Null
Status	Show the status of the App.	Null
Location	Show the installation path.	Null
Description	Show the description for this App.	Null

3.34 System > Tools

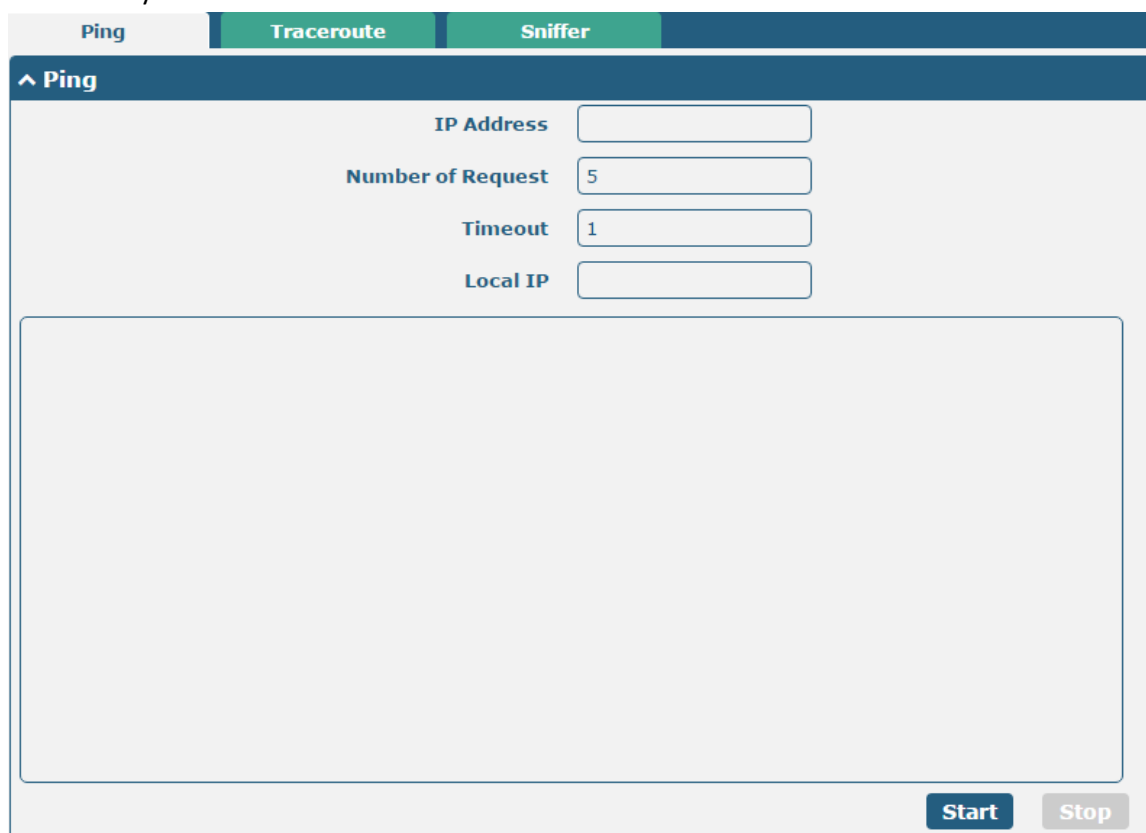
This section provides users three tools: Ping, Traceroute and Sniffer. The Ping tool is used to detect the network connectivity of the router.



Ping		
Item	Description	Default
IP address	Enter the ping's destination IP address or destination domain.	Null
Number of Requests	Specify the number of ping requests.	5
Timeout	Specify the timeout of ping request.	1
Local IP	Specify the local IP from cellular WAN, Ethernet WAN or Ethernet LAN. Null stands for selecting local IP address from these three automatically.	Null
	Click this button to start ping request, and the log will be displayed in the follow box.	Null
	Click this button to stop ping request.	--

Ping | Traceroute | Sniffer

Traceroute

Trace Address
 Trace Hops
 Trace Timeout

Start Stop

Traceroute		
Item	Description	Default
Trace Address	Enter the trace's destination IP address or destination domain.	Null
Trace Hops	Specify the max trace hops. Router will stop tracing if the trace hops has met max value no matter the destination has been reached or not.	30
Trace Timeout	Specify the timeout of Traceroute request.	1
Start	Click this button to start Traceroute request, and the log will be displayed in the follow box.	--
Stop	Click this button to stop Traceroute request.	--

Ping | Traceroute | Sniffer

Sniffer

Interface v
 Host
 Packets Request
 Protocol v
 Status

Start Stop

Capture Files

Index	File Name	File Size	Modification Time
1	18-04-18_16-17-29.cap	24	Wed Apr 18 16:17:30 2018

Sniffer		
Item	Description	Default
Interface	Choose the interface according to your Ethernet configuration.	All
Host	Filter the packet that contain the specify IP address.	Null
Packets Request	Set the packet number that the router can sniffer at a time.	1000
Protocol	Select from "All", "IP", "TCP", "UDP" and "ARP".	All
Port	Set the port number for TCP or UDP that is used in sniffer.	Null
Status	Show the current status of sniffer.	Null
	Click this button to start the sniffer.	--
	Click this button to stop the sniffer. Once you click this button, a new log file will be displayed in the following List.	--
Capture Files	Every times of sniffer log will be saved automatically as a new file. You can find the file from this Sniffer Traffic Data List and click to download the log, click to delete the log file. It can cache a maximum of 5 files.	Null

3.35 System > Profile

This section allows you to import or export the configuration file, and restore the router to factory default setting.

Profile
Rollback

^ Import Configuration File

Reset Other Settings to Default OFF ?

Ignore Invalid Settings ON ?

XML Configuration File No file chosen Import

^ Export Configuration File

Ignore Disabled Features OFF ?

Add Detailed Information OFF ?

Encrypt Secret Data ON ?

XML Configuration File Generate

^ Default Configuration

Save Running Configuration as Default Save ?

Restore to Default Configuration Restore

Profile		
Item	Description	Default
Import Configuration File		
Reset Other Settings to Default	Click the toggle button as "ON" to return other parameters to default settings.	OFF
Ignore Invalid Settings	Click the toggle button as "ON" to ignore invalid settings.	ON

XML Configuration File	Click on Choose File to locate the XML configuration file from your computer, and then click Import to import this file into your router.	--
Export Configuration File		
Ignore Disabled Features	Click the toggle button as "ON" to ignore the disabled features.	OFF
Add Detailed Information	Click the toggle button as "ON" to add detailed information.	OFF
Encrypt Secret Data	Click the toggle button as "ON" to encrypt the secret data.	ON
XML Configuration File	Click Generate button to generate the XML configuration file, and click Export to export the XML configuration file.	--
Default Configuration		
Save Running Configuration as Default	Click Save button to save the current running parameters as default configuration.	--
Restore to Default Configuration	Click "restore" button to restore the factory defaults.	--

Profile
Rollback

^ Configuration Rollback

Save as a Rollbackable Archive
Save
?

^ Configuration Archive Files

Index	File Name	File Size	Modification Time

Rollback		
Item	Description	Default
Configuration Rollback		
Save as a Rollbackable Archive	Create a save point manually. Additionally, the system will create a save point every day automatically if configuration changes.	--
Configuration Archive Files		
Configuration Archive Files	View the related information about configuration archive files, including name, size and modification time.	--

3.36 System > User Management

This section allows you to change your username and password, and create or manage user accounts. One router has only one super user who has the highest authority to modify, add and manage other common users.

Note: Your new password must be more than 5 character and less than 32 characters and may contain numbers, upper and lowercase letters, and standard symbols.

Super User

Common User

^ Super User Settings

New Username

?

Old Password

?

New Password

?

Confirm Password

Super User Settings		
Item	Description	Default
New Username	Enter a new username you want to create,If you do not want to change username, leave it blank. 5-32 characters, valid characters: a-z, A-Z, 0-9, @, #, \$, ., *, !, -	Null
Old Password	Enter the old password of your router. The default is "admin",5-32 characters, valid characters: a-z, A-Z, 0-9, @, #, \$, ., *, !, -	Null
New Password	Enter a new password you want to create, 5-32 characters, valid characters: a-z, A-Z, 0-9, @, #, \$, ., *, !, -	Null
Confirm Password	Enter the new password again to confirm.	Null

Super User

Common User

^ Common User Settings

Index	Role	Username
+		

Click + button to add a new common user. The maximum rule count is 5.

Common User

^ Common Users Settings

Index

Role

Visitor
v

Username

?

Password

?

Common User Settings		
Item	Description	Default
Index	Indicate the ordinal of the list.	--
Role	Select from "Visitor" and "Editor". <ul style="list-style-type: none">• Visitor: Users only can view the configuration of router under this level• Editor: Users can view and set the configuration of router under this level	Visitor
Username	Set the Username, 5-32 characters, valid characters: a-z, A-Z, 0-9, @, #, \$, ., *, !, -	Null
Password	Set the password, 5-32 characters, valid characters: a-z, A-Z, 0-9, @, #, \$, ., *, !, -	Null

Chapter 4 Configuration Examples

4.1 Cellular

4.1.1 Cellular Dial-Up

This section shows you how to configure the primary and backup SIM card for Cellular Dial-up. Connect the router correctly and insert two SIM, then open the configuration page. Under the homepage menu, click **Interface > Link Manager > Link Manager > General Settings**, choose “WWAN1” as the primary link and “WWAN2” as the backup link, and set “Cold Backup” as the backup mode, then click “Submit”.

Note: All data will be transferred via WWAN1 when choose WWAN1 as the primary link and set backup mode as cold backup. At the same time, WWAN2 is always offline as a backup link. All data transmission will be switched to WWAN2 when the WWAN1 is disconnected.

The screenshot shows the 'Link Manager' interface with the 'Status' tab selected. Under 'General Settings', the following options are visible:

- Primary Link: WWAN1
- Backup Link: WWAN2
- Backup Mode: Cold Backup
- Revert Interval: 0
- Emergency Reboot: OFF

Below this is the 'Link Settings' section, which contains a table with the following data:

Index	Type	Description	Connection Type	
1	WWAN1		DHCP	
2	WWAN2		DHCP	
3	WAN		DHCP	
4	WLAN		DHCP	

Click the edit button of WWAN1 to set its parameters according to the current ISP.

The screenshot shows the 'Link Manager' interface with the 'General Settings' tab selected for the WWAN1 link. The following options are visible:

- Index: 1
- Type: WWAN1
- Description: (empty field)

^ WWAN Settings

Automatic APN Selection ON OFF

Dialup Number

Authentication Type v

Aggressive Reset ON OFF ?

Switch SIM By Data Allowance ON OFF ?

Data Allowance ?

Billing Day ?

^ Ping Detection Settings ?

Enable ON OFF

Primary Server

Secondary Server

Interval ?

Retry Interval ?

Timeout ?

Max Ping Tries ?

^ Advanced Settings

NAT Enable ON OFF

Upload Bandwidth ?

Download Bandwidth

Overridden Primary DNS

Overridden Secondary DNS

Debug Enable ON OFF

Verbose Debug Enable ON OFF

When finished, click **Submit > Save & Apply** for the configuration to take effect.

The window is displayed below by clicking **Interface > Cellular > Advanced Cellular Settings**.

Index	SIM Card	Phone Number	Network Type	Band Select Type	
1	SIM1		Auto	All	
2	SIM2		Auto	All	

Click the edit button of SIM1 to set its parameters according to your application request.

Cellular

^ **General Settings**

Index	<input type="text" value="1"/>
SIM Card	<input type="text" value="SIM1"/> v
Phone Number	<input type="text"/>
PIN Code	<input type="text"/> ?
Extra AT Cmd	<input type="text"/> ?
Telnet Port	<input type="text" value="0"/> ?

^ **Cellular Network Settings**

Network Type	<input type="text" value="Auto"/> v ?
Band Select Type	<input type="text" value="All"/> v ?

^ **Advanced Settings**

Debug Enable	<input type="checkbox"/> ON <input type="checkbox"/> OFF
Verbose Debug Enable	<input type="checkbox"/> ON <input type="checkbox"/> OFF

When finished, click **Submit > Save & Apply** for the configuration to take effect.

4.1.2 SMS Remote Control

The router supports remote control via SMS. You can use following commands to get the status of the router, and set all the parameters. There are three authentication types for SMS control. You can select from “Password”, “Phonenum” or “Both”.

An SMS command has the following structure:

1. Password mode—**Username: Password; cmd1; cmd2; cmd3; ...cmdn** (available for every phone number).
2. Phonenum mode-- **Password; cmd1; cmd2; cmd3; ... cmdn** (available when the SMS was sent from the phone number which had been added in R2100’s phone group).
3. Both mode-- **Username: Password; cmd1; cmd2; cmd3; ...cmdn** (available when the SMS was sent from the phone number which had been added in R2100’s phone group).

SMS command Explanation:

1. User name and Password: use the same username and password as WEB manager for authentication.
2. cmd1, cmd2, cmd3 to Cmdn, the command format is the same as the CLI command, more details about CLI cmd please refer to **Chapter 5 Introductions for CLI**.

Note: Download the configure XML file from the configured web browser. The format of SMS control command can refer to the data of the XML file.

Go to **System > Profile > Export Configuration File**, click **Generate** to generate the XML file and click **Export** to export the XML file.

Profile	Rollback
^ Import Configuration File	
Reset Other Settings to Default	<input type="checkbox"/> ON <input checked="" type="checkbox"/> OFF ?
Ignore Invalid Settings	<input checked="" type="checkbox"/> ON <input type="checkbox"/> OFF ?
XML Configuration File	<input type="button" value="Choose File"/> No file chosen <input type="button" value="Import"/>
^ Export Configuration File	
Ignore Disabled Features	<input type="checkbox"/> ON <input checked="" type="checkbox"/> OFF ?
Add Detailed Information	<input type="checkbox"/> ON <input checked="" type="checkbox"/> OFF ?
Encrypt Secret Data	<input checked="" type="checkbox"/> ON <input type="checkbox"/> OFF ?
XML Configuration File	<input type="button" value="Generate"/>
^ Default Configuration	
Save Running Configuration as Default	<input type="button" value="Save"/> ?
Restore to Default Configuration	<input type="button" value="Restore"/>

XML command:

```
<lan>
<network max_entry_num="2">
<id>1</id>
<interface>lan0</interface>
<ip>172.16.24.24</ip>
<netmask>255.255.0.0</netmask>
<mtu>1500</mtu>
```

SMS cmd:

```
set lan network 1 interface lan0
set lan network 1 ip 172.16.24.24
set lan network 1 netmask 255.255.0.0
set lan network 1 mtu 1500
```

- The semicolon character (;) is used to separate more than one command packed in a single SMS.
- E.g.

admin:admin;status system

In this command, username is "admin", password is "admin", and the function of the command is to get the system status.

SMS received:

```
hardware_version = 1.2
firmware_version = "3.0.0"
kernel_version = 4.1.0
device_model = R2100
serial_number = 201612221052
uptime = "0 days, 00:40:21"
system_time = "Mon Feb 27 09:52:52 2017"
```

admin:admin;reboot

In this command, username is “admin”, password is “admin”, and the command is to reboot the Router.

SMS received:

OK

admin:admin;set firewall remote_ssh_access false;set firewall remote_telnet_access false

In this command, username is “admin”, password is “admin”, and the command is to disable the remote_ssh and remote_telnet access.

SMS received:

OK

OK

admin:admin; set lan network 1 interface lan0;set lan network 1 ip 172.16.24.24;set lan network 1 netmask 255.255.0.0;set lan network 1 mtu 1500

In this command, username is “admin”, password is “admin”, and the commands is to configure the LAN parameter.

SMS received:

OK

OK

OK

OK

4.2 VPN Configuration Example

4.2.1 IPsec VPN

IPsec VPN example topology (the IKE and SA parameters must be configured on the server and client): The configuration of server and client is as follows.

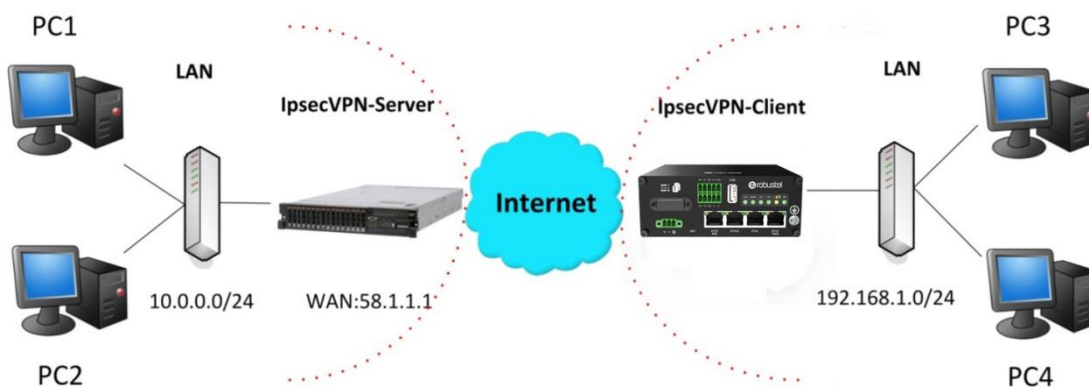

The configuration of server and client is as follows.

IPsec VPN_Server:

Cisco 2811:

```

Router>enable
Router#config
Configuring from terminal, memory, or network [terminal]?
Enter configuration commands, one per line. End with CNTL/Z.
Router(config)#crypto isakmp policy 10
Router(config-isakmp)#?
  authentication  Set authentication method for protection suite
  encryption     Set encryption algorithm for protection suite
  exit           Exit from ISAKMP protection suite configuration mode
  group          Set the Diffie-Hellman group
  hash           Set hash algorithm for protection suite
  lifetime       Set lifetime for ISAKMP security association
  no             Negate a command or set its defaults
Router(config-isakmp)#encryption 3des
Router(config-isakmp)#hash md5
Router(config-isakmp)#authentication pre-share
Router(config-isakmp)#group 2
Router(config-isakmp)#exit
Router(config)#crypto isakmp ?
  client  Set client configuration policy
  enable  Enable ISAKMP
  key     Set pre-shared key for remote peer
  policy  Set policy for an ISAKMP protection suite
Router(config)#crypto isakmp key cisco address 0.0.0.0 0.0.0.0

Router(config)#crypto ?
  dynamic-map  Specify a dynamic crypto map template
  ipsec        Configure IPSEC policy
  isakmp       Configure ISAKMP policy
  key          Long term key operations
  map          Enter a crypto map
Router(config)#crypto ipsec ?
  security-association  Security association parameters
  transform-set         Define transform and settings
Router(config)#crypto ipsec transform-set Trans ?
  ah-md5-hmac  AH-HMAC-MD5 transform
  ah-sha-hmac  AH-HMAC-SHA transform
  esp-3des     ESP transform using 3DES(EDE) cipher (168 bits)
  esp-aes      ESP transform using AES cipher
  esp-des      ESP transform using DES cipher (56 bits)
  esp-md5-hmac ESP transform using HMAC-MD5 auth
  esp-sha-hmac ESP transform using HMAC-SHA auth
Router(config)#crypto ipsec transform-set Trans esp-3des esp-md5-hmac

Router(config)#ip access-list extended vpn
Router(config-ext-nacl)#permit ip 10.0.0.0 0.0.0.255 192.168.1.0 0.0.0.255
Router(config-ext-nacl)#exit

Router(config)#crypto map cry-map 10 ipsec-isakmp
% NOTE: This new crypto map will remain disabled until a peer
and a valid access list have been configured.
Router(config-crypto-map)#match address vpn
Router(config-crypto-map)#set transform-set Trans
Router(config-crypto-map)#set peer 202.100.1.1
Router(config-crypto-map)#exit

Router(config)#interface fastEthernet 0/0
Router(config-if)#ip address 58.1.1.1 255.255.255.0
Router(config-if)#cr
Router(config-if)#crypto map cry-map
*Jan 3 07:16:26.785: %CRYPTO-6-ISAKMP_ON_OFF: ISAKMP is ON

```

IPsec VPN_Client:

The window is displayed as below by clicking **VPN > IPsec > Tunnel**.

General	Tunnel	Status	x509			
^ Tunnel Settings						
Index	Enable	Description	Gateway	Local Subnet	Remote Subnet	+

Click **+** button and set the parameters of IPsec Client as below.

Tunnel

^ General Settings

Index

Enable ON OFF

Description

Gateway ?

Mode v

Protocol v

Local Subnet ?

Remote Subnet ?

^ IKE Settings

Negotiation Mode v

Authentication Algorithm v

Encryption Algorithm v

IKE DH Group v

Authentication Type v

PSK Secret

Local ID Type v

Remote ID Type v

IKE Lifetime ?

^ SA Settings

Encrypt Algorithm v

Authentication Algorithm v

PFS Group v

SA Lifetime ?

DPD Interval ?

DPD Failures ?

^ Advanced Settings

Enable Compression ON OFF

Expert Options ?

When finished, click **Submit > Save & Apply** for the configuration to take effect.

The comparison between server and client is as below.

Server (Cisco 2811)

```

Router>enable
Router#config
Configuring from terminal, memory, or network [terminal]?
Enter configuration commands, one per line. End with CNTL/Z.
Router(config)#crypto isakmp policy 10
Router(config-isakmp)#?
 authentication Set authentication method for protection suite
 #cryptoprot Set encryption algorithm for protection suite
 exit Exit from ISAKMP protection suite configuration mode
 group Set the Diffie-Hellman group
 hash Set hash algorithm for protection suite
 lifetime Set lifetime for ISAKMP security association
 no Negate a command or set its defaults
Router(config-isakmp)#encryption 3des
Router(config-isakmp)#hash md5
Router(config-isakmp)#authentication pre-share
Router(config-isakmp)#group 2
Router(config-isakmp)#exit
Router(config)#crypto isakmp ?
 client Set client configuration policy
 enable Enable ISAKMP
 key Set pre-shared key for remote peer
 policy Set policy for an ISAKMP protection suite
Router(config)#crypto isakmp key cisco address 0.0.0.0 0.0.0.0

Router(config)#crypto ?
 dynamic-map Specify a dynamic crypto map template
 ipsec Configure IPSEC policy
 isakmp Configure ISAKMP policy
 key Long term key operations
 map Enter a crypto map
Router(config)#crypto ipsec ?
 security-association Security association parameters
 transform-set Define transform and settings
Router(config)#crypto ipsec transform-set Trans ?
 ah-md5-hmac AH-HMAC-MD5 transform
 ah-sha-hmac AH-HMAC-SHA transform
 esp-3des ESP transform using 3DES (EDE) cipher (168 bits)
 esp-aes ESP transform using AES cipher
 esp-des ESP transform using DES cipher (56 bits)
 esp-md5-hmac ESP transform using HMAC-MD5 auth
 esp-sha-hmac ESP transform using HMAC-SHA auth
Router(config)#crypto ipsec transform-set Trans esp-3des esp-md5-hmac

Router(config)#ip access-list extended vpn
Router(config-ext-nacl)#permit ip 10.0.0.0 0.0.0.255 192.168.1.0 0.0.0.255
Router(config-ext-nacl)#exit

Router(config)#crypto map cry-map 10 ipsec-isakmp
! NOTE: This new crypto map will remain disabled until a peer
and a valid access list have been configured.
Router(config-crypto-map)#match address vpn
Router(config-crypto-map)#set transform-set Trans
Router(config-crypto-map)#set peer 202.100.1.1
Router(config-crypto-map)#exit

Router(config)#interface fastEthernet 0/0
Router(config-if)#ip address 58.1.1.1 255.255.255.0
Router(config-if)#cr
Router(config-if)#crypto map cry-map
*Jan 3 07:16:26.795: %CRYPTO-6-ISAKMP_ON_OFF: ISAKMP is ON
                    
```

Client (R2100)

The screenshot shows the configuration interface for the Client (R2100) with the following settings:

- Tunnel Settings:** Index 1, Enable ON, Gateway 58.1.1.1, Mode Tunnel, Protocol ESP, Local Subnet 192.168.1.0, Remote Subnet 255.255.255.0.
- IKE Settings:** Negotiation Mode Main, Authentication Algorithm MD5, Encrypt Algorithm 3DES, IKE DH Group MODP(1024), Authentication Type PSK, PSK Secret *****.
- SA Settings:** Encrypt Algorithm 3DES, Authentication Algorithm MD5, PFS Group MODP(1024), SA Lifetime 28800, DPD Interval 60, DPD Failures 180.
- Advanced Settings:** Enable Compression OFF.

IKE Setting in Client must be consistent with server.

SA Setting in Client must be consistent with server.

4.2.2 OpenVPN

OpenVPN supports both client and P2P (peer-to-peer) modes. Here, the client is used as an example. The sample topology is shown below:

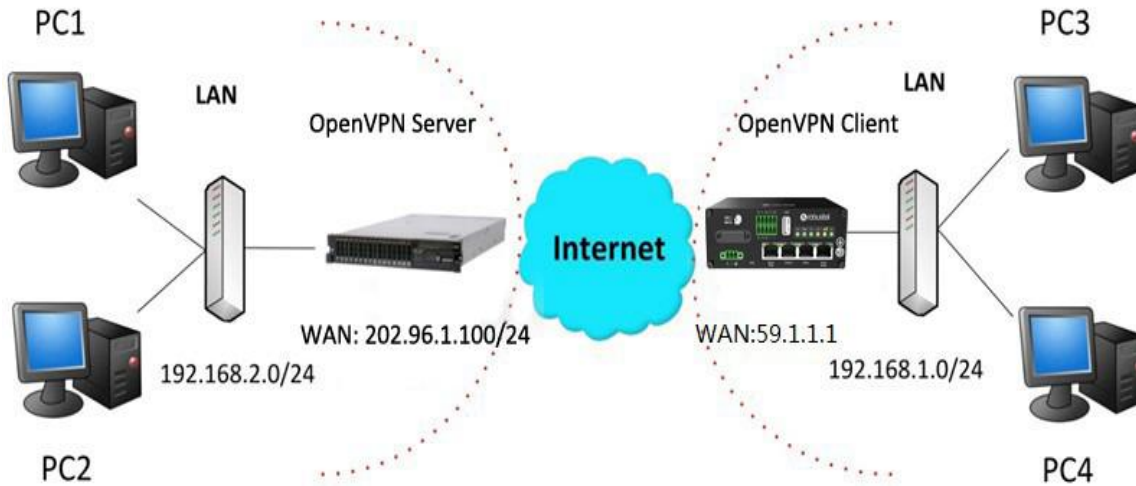

The configuration of two points is as follows.

OpenVPN_Server:

Generate relevant OpenVPN certificate on the server side firstly, and refer to the following commands to configuration the Server:

```
local 202.96.1.100
mode server
port 1194
proto udp
dev tun
tun-mtu 1500
fragment 1500
ca ca.crt
cert Server01.crt
key Server01.key
dh dh1024.pem
server 10.8.0.0 255.255.255.0
ifconfig-pool-persist ipp.txt
push "route 192.168.3.0 255.255.255.0"
client-config-dir ccd
route 192.168.1.0 255.255.255.0
keepalive 10 120
cipher BF-CBC
comp-lzo
max-clients 100
persist-key
persist-tun
status openvpn-status.log
verb 3
```

Note: For more configuration details, please contact your technical support engineer.

OpenVPN_Client:

Click **VPN > OpenVPN > OpenVPN** as below.

OpenVPN	Status	x509					
^ Tunnel Settings							
Index	Enable	Description	Mode	Protocol	Server Address	Interface Type	+

Click **+** to configure the Client01 as below.

^ General Settings

Index	<input type="text" value="1"/>
Enable	<input checked="" type="checkbox"/> ON <input type="checkbox"/> OFF
Description	<input type="text" value="Client01"/>
Mode	<input type="text" value="Client"/> v
Protocol	<input type="text" value="UDP"/> v
Server Address	<input type="text" value="202.96.1.100"/>
Server Port	<input type="text" value="1194"/>
Interface Type	<input type="text" value="TUN"/> v
Authentication Type	<input type="text" value="X509CA"/> v ?
Encrypt Algorithm	<input type="text" value="BF"/> v
Renegotiation Interval	<input type="text" value="86400"/> ?
Keepalive Interval	<input type="text" value="20"/> ?
Keepalive Timeout	<input type="text" value="120"/> ?
Private Key Password	<input type="password" value="•••••"/>
Enable Compression	<input checked="" type="checkbox"/> ON <input type="checkbox"/> OFF
Enable NAT	<input checked="" type="checkbox"/> ON <input type="checkbox"/> OFF
Verbose Level	<input type="text" value="3"/> v ?

^ Advanced Settings

Enable HMAC Firewall	<input type="checkbox"/> ON <input checked="" type="checkbox"/> OFF
Enable PKCS#12	<input type="checkbox"/> ON <input checked="" type="checkbox"/> OFF
Enable nsCertType	<input type="checkbox"/> ON <input checked="" type="checkbox"/> OFF
Expert Options	<input type="text" value="fragment 1500"/> ?

When finished, click **Submit > Save & Apply** for the configuration to take effect.

4.2.3 GRE VPN

The configuration of two points is as follows.

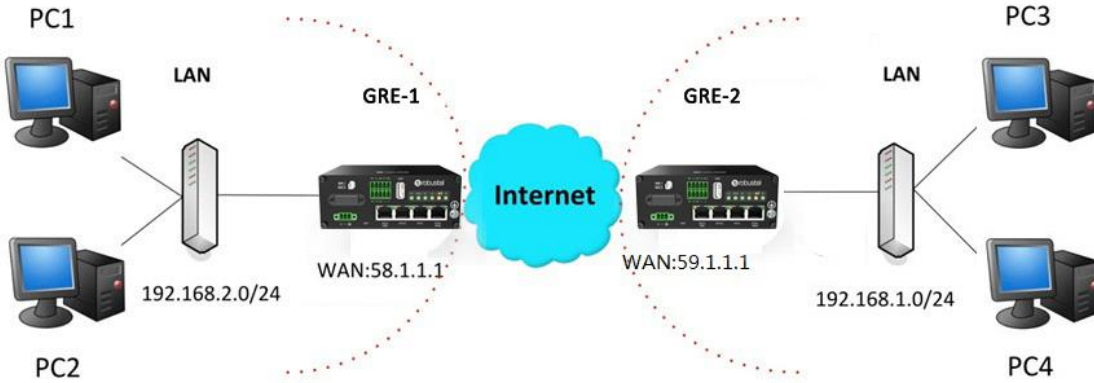

GRE-1:

The window is displayed as below by clicking **VPN > GRE > GRE**.

GRE			
Status			
^ Tunnel Settings			
Index	Enable	Description	Remote IP Address
			+

Click **+** button and set the parameters of GRE-1 as below.

^ Tunnel Settings	
Index	<input type="text" value="1"/>
Enable	<input checked="" type="checkbox"/> ON <input type="checkbox"/> OFF
Description	<input type="text" value="GRE-1"/>
Remote IP Address	<input type="text" value="59.1.1.1"/>
Local Virtual IP Address	<input type="text" value="10.8.0.1"/>
Remote Virtual IP Address	<input type="text" value="10.8.0.2"/>
Enable Default Route	<input type="checkbox"/> ON <input checked="" type="checkbox"/> OFF
Enable NAT	<input type="checkbox"/> ON <input checked="" type="checkbox"/> OFF
Secrets	<input type="password" value="•••••"/>

When finished, click **Submit > Save & Apply** for the configuration to take effect.

GRE-2:

Click **+** button and set the parameters of GRE-1 as below.

^ Tunnel Settings

Index: 1

Enable: ON OFF

Description: GRE-2

Remote IP Address: 58.1.1.1

Local Virtual IP Address: 10.8.0.2

Remote Virtual IP Address: 10.8.0.1

Enable Default Route: ON OFF

Enable NAT: ON OFF

Secrets: *****

When finished, click **Submit > Save & Apply** for the configuration to take effect.

The comparison between GRE-1 and GRE-2 is as below.

GRE-1	GRE-2
^ Tunnel Settings	^ Tunnel Settings
Index: 1	Index: 1
Enable: <input checked="" type="checkbox"/> ON <input type="checkbox"/> OFF	Enable: <input checked="" type="checkbox"/> ON <input type="checkbox"/> OFF
Description: GRE-1	Description: GRE-2
Remote IP Address: 59.1.1.1 GRE-1 public IP	Remote IP Address: 58.1.1.1 GRE-2 public IP
Local Virtual IP Address: 10.8.0.1 GRE-1 tunnel IP	Local Virtual IP Address: 10.8.0.2 GRE-2 tunnel IP
Remote Virtual IP Address: 10.8.0.2 GRE-2 tunnel IP	Remote Virtual IP Address: 10.8.0.1 GRE-1 tunnel IP
Enable Default Route: <input type="checkbox"/> OFF	Enable Default Route: <input type="checkbox"/> OFF
Enable NAT: <input type="checkbox"/> OFF set the same secret as GRE-2	Enable NAT: <input type="checkbox"/> OFF set the same secret as GRE-1
Secrets: *****	Secrets: *****

Chapter 5 Introductions for CLI

5.1 What Is CLI

The Command Line Interface (CLI) is a set of software interfaces that provide another way to configure device parameters. Users can connect to the router through SSH or telnet to configure CLI commands. After establishing a Telnet or SSH connection with the router, enter the login account and password (default admin/admin) to enter the router's configuration mode, as shown below.

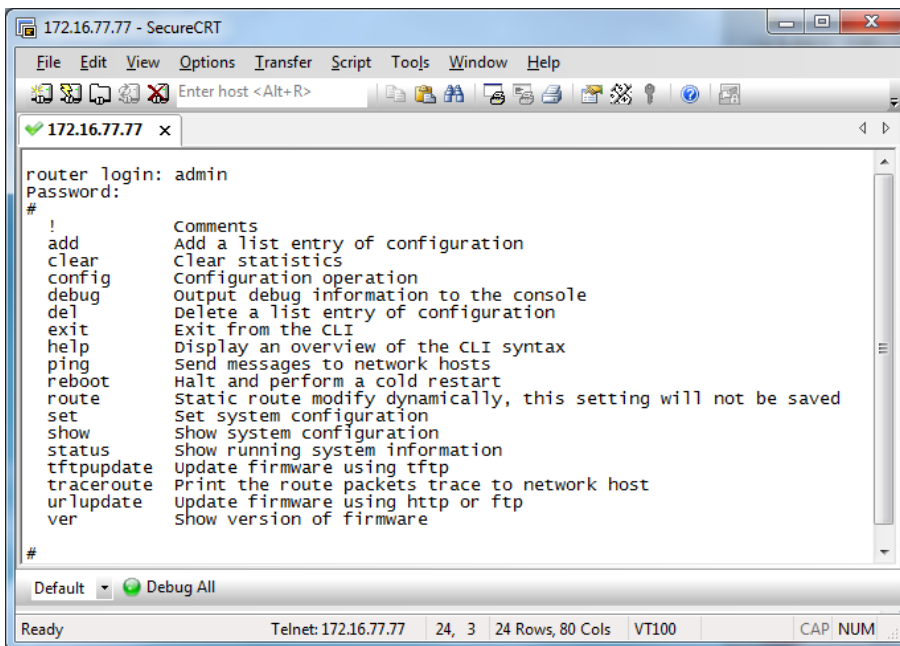

```

172.16.77.77 - SecureCRT
File Edit View Options Transfer Script Tools Window Help
Enter host <Alt+R>
172.16.77.77 x
router login: admin
Password:
#
!           Comments
add         Add a list entry of configuration
clear       Clear statistics
config      Configuration operation
debug       Output debug information to the console
del         Delete a list entry of configuration
exit        Exit from the CLI
help        Display an overview of the CLI syntax
ping        Send messages to network hosts
reboot      Halt and perform a cold restart
route       Static route modify dynamically, this setting will not be saved
set         Set system configuration
show        Show system configuration
status      Show running system information
tftpupdate  Update firmware using tftp
traceroute  Print the route packets trace to network host
urlupdate   Update firmware using http or ftp
ver         Show version of firmware
#
Default  Debug All
Ready           Telnet: 172.16.77.77  24, 3  24 Rows, 80 Cols  VT100  CAP NUM

```

Route login:

Router login: admin

Password: admin

#

CLI commands:

? (**Note:** the '?' won't display on the page.)

!	Comments
add	Add a list entry of configuration
clear	Clear statistics
config	Configuration operation
debug	Output debug information to the console
del	Delete a list entry of configuration
exit	Exit from the CLI
help	Display an overview of the CLI syntax
ping	Send messages to network hosts

reboot	Halt and perform a cold restart
route	Static route modify dynamically, this setting will not be saved
set	Set system configuration
show	Show system configuration
status	Show running system information
tftpupdate	Update firmware using tftp
traceroute	Print the route packets trace to network host
urlupdate	Update firmware using http or ftp
ver	Show version of firmware

5.2 How to Configure the CLI

The following list is a description of the help information commands and the error commands encountered during configuration.

Commands /tips	Description
?	Typing a question mark “?” will show you the help information. Example: # config (tick ‘?’) config Configuration operation # config (tick space key+ +’?’) commit Save the configuration changes and take effect changed configuration save_and_apply Save the configuration changes and take effect changed configuration loaddefault Restore Factory Configuration
Ctrl+c	Press these two keys at the same time, except its “copy” function but also can be used for “break” out of the setting program.
Syntax error: The command is not completed	Command is not completed.
Tick space key+ Tab key	It can help you finish you command. Example: # config (tick Enter key) Syntax error: The command is not completed # config (tick space key+ Tab key) commit save_and_apply loaddefault
#config commit # config save_and_apply	When your setting finished, you should enter those commands to make your setting take effect on the device. Note: Commit and save_and_apply plays the same role.

5.3 Commands Reference

Commands	Syntax	Description
Debug	Debug <i>parameters</i>	Turn on or turn off debug function
Show	Show <i>parameters</i>	Show current configuration of each function
Set	Set <i>parameters</i>	All the function parameters are set by commands set and add, the difference is that set is for the single parameter and add is for the list parameter
Add	Add <i>parameters</i>	

Note: Download the config.XML file from the configured web browser. The command format can refer to the config.XML file format.

5.4 Quick Start with Configuration Examples

The best and quickest way to master CLI is firstly to view all features from the webpage and then read all CLI commands at a time, finally learn to configure it with some reference examples.

Example 1: Show current version

```
# status system
firmware_version = "1.0.4 "
kernel_version = 3.18.92
device_model = "R2110"
serial_number = 201712221052
uptime = "0 days, 00:06:58"
system_time = "Wed Feb 15 18:21:46 2017"
```

Example 2: Update firmware via tftp

```
# tftpupdate (space+?)
firmware New firmware
# tftpupdate firmware (space+?)
String Firmware name
# tftpupdate firmware R2110-firmware-sysupgrade-unknown.ruf host 192.168.100.99 //enter a new firmware name
Downloading
R2110-firmware-s 100% |*****| 5018k 0: 00: 00 ETA
Flashing
Checking 100%
Decrypting 100%
Flashing 100%
Verifying 100%
Verify Success
upgrade success //update success
# config save_and_apply
OK //save and apply current configuration, make you configuration effect
```

Example 3: Set link-manager

```
# set
# set (space+?)
at_over_telnet AT Over Telnet
cellular Cellular
ddns Dynamic DNS
ethernet Ethernet
event Event Management
firewall Firewall
```

```

gre                GRE
ipsec              IPsec
lan                Local Area Network
link_manager       Link Manager
ntp                NTP
openvpn            OpenVPN
reboot             Automatic Reboot
robustlink         Robustlink
route              Route
sms                SMS
snmp               SNMP agent
ssh                SSH
syslog             Syslog
system             System
user_management    User Management
vrrp               VRRP
web_server         Web Server
# set link_management
primary_link       Primary Link
backup_link        Backup Link
backup_mode        BackSup Mode
emergency_reboot   Emergency Reboot
link               Link Settings
# set link_management primary_link (space+?)
Enum Primary Link (wwan1/wwan2/wan/wlan)
# set link_management primary_link wwan1           //select "wwan1" as primary_link
OK                                                  //setting succeed
set link_manager link 1
type              Type
desc              Description
connection_type   Connection Type
wwan              WWAN Settings
static_addr       Static Address Settings
pppoe             PPPoE Settings
ping              Ping Settings
mtu               MTU
dns1_overridden   Overridden Primary DNS
dns2_overridden   Overridden Secondary DNS
# set link_manager link 1 type wwan1
OK
# set link_manager link 1 wwan
auto_apn          Automatic APN Selection
apn               APN
username          Username
password          Password
dialup_number     Dialup Number

```

```

auth_type           Authentication Type
aggressive_reset    Aggressive Reset
switch_by_data_allowance  Switch SIM By Data Allowance
data_allowance      Data Allowance
billing_day         Billing Day
# set link_manager link 1 wwan switch_by_data_allowance true
OK
#
# set link_manager link 1 wwan data_allowance 100           //open cellular switch_by_data_traffic
OK                                                         //setting succeed
# set link_manager link 1 wwan billing_day 1               //setting specifies the day of month for billing
OK                                                         // setting succeed
...
# config save_and_apply
OK                                                         // save and apply current configuration, make you configuration effect

```

Example 4: Set LAN IP address

```

# set Ethernet port_setting 2 port_assignment lan0         // Set Table 2 (eth1) to lan0
OK
# config save_and_apply                                    // Make the configuration take effect
OK

```

Example 5: Set LAN IP address

```

# show lan all
network {
    id = 1
    interface = lan0
    ip = 192.168.0.1
    netmask = 255.255.255.0
    mtu = 1500
    dhcp {
        enable = true
        mode = server
        relay_server = ""
        pool_start = 192.168.0.2
        pool_end = 192.168.0.100
        netmask = 255.255.255.0
        router = ""
        primary_dns = ""
        secondary_dns = ""
        wins_server = ""
        lease_time = 120
        expert_options = ""
    }
}

```

```

        debug_enable = false
    }
}
multi_ip {
    id = 1
    interface = lan0
    ip = 172.16.24.24
    netmask = 255.255.0.0
}
#
# set lan
network      Network Settings
multi_ip     Multiple IP Address Settings
vlan         VLAN
# set lan network 1(space+?)
interface    Interface
ip           IP Address
netmask     Netmask
mtu         MTU
dhcp        DHCP Settings
# set lan network 1 interface lan0
OK
# set lan network 1 ip 172.16.24.24           //set IP address for lan
OK                                             //setting succeed
# set lan network 1 netmask 255.255.0.0
OK
#
...
# config save_and_apply
OK                                             // save and apply current configuration, make you configuration effect

```

Example 6: CLI for setting Cellular

```

# show cellular all
sim {
    id = 1
    card = sim1
    phone_number = ""
    extra_at_cmd = ""
    network_type = auto
    band_select_type = all
    band_gsm_850 = false
    band_gsm_900 = false
    band_gsm_1800 = false
    band_gsm_1900 = false
}

```

```
band_wcdma_850 = false
band_wcdma_900 = false
band_wcdma_1900 = false
band_wcdma_2100 = false
band_lte_800 = false
band_lte_850 = false
band_lte_900 = false
band_lte_1800 = false
band_lte_1900 = false
band_lte_2100 = false
band_lte_2600 = false
band_lte_1700 = false
band_lte_700 = false
band_tdd_lte_2600 = false
band_tdd_lte_1900 = false
band_tdd_lte_2300 = false
band_tdd_lte_2500 = false
}
sim {
  id = 2
  card = sim2
  phone_number = ""
  extra_at_cmd = ""
  network_type = auto
  band_select_type = all
  band_gsm_850 = false
  band_gsm_900 = false
  band_gsm_1800 = false
  band_gsm_1900 = false
  band_wcdma_850 = false
  band_wcdma_900 = false
  band_wcdma_1900 = false
  band_wcdma_2100 = false
  band_lte_800 = false
  band_lte_850 = false
  band_lte_900 = false
  band_lte_1800 = false
  band_lte_1900 = false
  band_lte_2100 = false
  band_lte_2600 = false
  band_lte_1700 = false
  band_lte_700 = false
  band_tdd_lte_2600 = false
  band_tdd_lte_1900 = false
  band_tdd_lte_2300 = false
  band_tdd_lte_2500 = false
```

```

}
# set(space+?)
at_over_telnet  cellular      ddns      dhcp      dns
event          firewall    ipsec     lan       link_manager
ntp            openvpn   reboot    route     serial_port
sms            snmp      syslog    system    user_management
vrrp
# set cellular(space+?)
  sim  SIM Settings
# set cellular sim(space+?)
  Integer  Index (1..2)

# set cellular sim 1(space+?)
  card          SIM Card
  phone_number  Phone Number
  extra_at_cmd  Extra AT Cmd
  network_type  Network Type
  band_select_type  Band Select Type
  band_gsm_850  GSM 850
  band_gsm_900  GSM 900
  band_gsm_1800 GSM 1800
  band_gsm_1900 GSM 1900
  band_wcdma_850 WCDMA 850
  band_wcdma_900 WCDMA 900
  band_wcdma_1900 WCDMA 1900
  band_wcdma_2100 WCDMA 2100
  band_lte_800   LTE 800 (band 20)
  band_lte_850   LTE 850 (band 5)
  band_lte_900   LTE 900 (band 8)
  band_lte_1800  LTE 1800 (band 3)
  band_lte_1900  LTE 1900 (band 2)
  band_lte_2100  LTE 2100 (band 1)
  band_lte_2600  LTE 2600 (band 7)
  band_lte_1700  LTE 1700 (band 4)
  band_lte_700   LTE 700 (band 17)
  band_tdd_lte_2600 TDD LTE 2600 (band 38)
  band_tdd_lte_1900 TDD LTE 1900 (band 39)
  band_tdd_lte_2300 TDD LTE 2300 (band 40)
  band_tdd_lte_2500 TDD LTE 2500 (band 41)
# set cellular sim 1 phone_number 18620435279
OK
...
# config save_and_apply
OK                                     // save and apply current configuration, make you configuration effect

```

Glossary

Abbr.	Description
AC	Alternating Current
APN	Access Point Name of GPRS Service Provider Network
ASCII	American Standard Code for Information Interchange
CE	Conformité Européene (European Conformity)
CHAP	Challenge Handshake Authentication Protocol
CLI	Command Line Interface for batch scripting
CSD	Circuit Switched Data
CTS	Clear to Send
dB	Decibel
dBi	Decibel Relative to an Isotropic radiator
DC	Direct Current
DCD	Data Carrier Detect
DCE	Data Communication Equipment (typically modems)
DCS 1800	Digital Cellular System, also referred to as PCN
DI	Digital Input
DO	Digital Output
DSR	Data Set Ready
DTE	Data Terminal Equipment
DTMF	Dual Tone Multi-frequency
DTR	Data Terminal Ready
EDGE	Enhanced Data rates for Global Evolution of GSM and IS-136
EMC	Electromagnetic Compatibility
EMI	Electro-Magnetic Interference
ESD	Electrostatic Discharges
ETSI	European Telecommunications Standards Institute
FDD LTE	Frequency Division Duplexing Long Term Evolution
GND	Ground
GPRS	General Packet Radio Service
GRE	generic route encapsulation
GSM	Global System for Mobile Communications
HSPA	High Speed Packet Access
ID	identification data
IMEI	International Mobile Equipment Identification
IP	Internet Protocol
IPSec	Internet Protocol Security
kbps	kbits per second
L2TP	Layer 2 Tunneling Protocol

Abbr.	Description
LAN	local area network
LED	Light Emitting Diode
M2M	Machine to Machine
MAX	Maximum
Min	Minimum
MO	Mobile Originated
MS	Mobile Station
MT	Mobile Terminated
OpenVPN	Open Virtual Private Network
PAP	Password Authentication Protocol
PC	Personal Computer
PCN	Personal Communications Network, also referred to as DCS 1800
PCS	Personal Communication System, also referred to as GSM 1900
PDU	Protocol Data Unit
PIN	Personal Identity Number
PLCs	Program Logic Control System
PPP	Point-to-point Protocol
PPTP	Point to Point Tunneling Protocol
PSU	Power Supply Unit
PUK	Personal Unblocking Key
R&TTE	Radio and Telecommunication Terminal Equipment
RF	Radio Frequency
RTS	Request to Send
RTU	Remote Terminal Unit
Rx	Receive Direction
SDK	Software Development Kit
SIM	subscriber identification module
SMA antenna	Stubby antenna or Magnet antenna
SMS	Short Message Service
SNMP	Simple Network Management Protocol
TCP/IP	Transmission Control Protocol / Internet Protocol
TE	Terminal Equipment, also referred to as DTE
Tx	Transmit Direction
UART	Universal Asynchronous Receiver-transmitter
UMTS	Universal Mobile Telecommunications System
USB	Universal Serial Bus
USSD	Unstructured Supplementary Service Data
VDC	Volts Direct Current
VLAN	Virtual Local Area Network
VPN	Virtual Private Network
VSWR	Voltage Stationary Wave Ratio

Abbr.	Description
WAN	Wide Area Network
VSWR	Voltage Stationary Wave Ratio
WAN	Wide Area Network

Guangzhou Robustel LTD

Address: 3rd Floor, Building F, Kehui Park, No.95 Daguan Road,
Guangzhou, China 510660

Tel: 86-20-29019902

Email: info@robustel.com